



# aks-SB L

## Instructions for use

Translation of the original instructions for use



Date: 2022-06-22 | Version 01



"Certified quality management system for the development, production and distribution of equipment and accessories for patient positioning and patient transport"



DIN EN ISO 13485

CE aks

## TABLE OF CONTENTS

<b>1 Introduction</b>	<b>4</b>
1.1 Explanation of the symbols used	6
<b>2 Intended use</b>	<b>7</b>
2.1 Intended purpose	7
2.2 Indication	7
2.3 Contraindication	7
2.4 Side effects	7
<b>3 Safety instructions</b>	<b>8</b>
3.1 Explanation of the groups referred to	8
3.2 General safety instructions	10
3.3 Safety instructions for the operator	12
3.4 Safety instructions for the user	14
<b>4 Scope of delivery</b>	<b>15</b>
<b>5 Product overview</b>	<b>18</b>
<b>6 Assembly</b>	<b>19</b>
6.1 Assembling the homecare bed	20
6.2 Assembling the controller	23
6.3 Assembling the uplifter and grab handle	24
<b>7 Commissioning</b>	<b>25</b>
<b>8 Operation</b>	<b>26</b>
8.1 Castors	26
8.2 Side bars	27
8.3 Uplifter	29
8.4 Bed surface	30
8.5 Manual control unit	32
8.6 Lock function	33
8.7 Emergency lowering	33
8.8 Mains power cut-off	35
<b>9 Patient transport</b>	<b>36</b>
<b>10 Accessories/combinations</b>	<b>37</b>
<b>11 Troubleshooting</b>	<b>38</b>
<b>12 Cleaning/disinfecting</b>	<b>39</b>
12.1 General cleaning and disinfecting instructions	40
12.2 Cleaning by the user/operator	41
12.3 Disinfection by the user/operator	41
12.4 Approved disinfectants	41
<b>13 Storage</b>	<b>42</b>
13.1 Shutdown	42
<b>14 Reuse</b>	<b>43</b>
<b>15 Service life</b>	<b>43</b>
<b>16 Disposal</b>	<b>44</b>

<b>17 Warranty</b>	<b>46</b>
<b>18 Declaration of conformity</b>	<b>46</b>
<b>19 Maintenance</b>	<b>47</b>
19.1 General maintenance instructions	47
19.2 Removing/replacing the batteries	49
19.3 Maintenance schedule: Inspection by the operator	50
19.4 Maintenance schedule: Inspection by the user	57
<b>20 Product labelling</b>	<b>58</b>
<b>21 Technical data</b>	<b>63</b>

### Version history

Version	Date	Change
01	2022-06-22	Adaptations to Regulation (EU) 2017/745

## 1 Introduction

Dear customer,

Thank you for choosing an aks GmbH product. We appreciate your vote of confidence.

**Read the instructions for use in full before using the product for the first time and before each reuse, in order to avoid damage or risks due to misuse. The instructions contain important information and notes that are necessary for proper use of the product.**

**If you have queries, particularly regarding the safety instructions, please contact your authorised dealer. Do not use the product until all matters have been clarified. This is to prevent injuries and damage due to incorrect use.**

**Keep these instructions for use within reach of the user and include them with the product if it passes to another owner.**

We reserve the right to make changes and amendments. The text and illustrations may therefore not fully match the delivered product.

If you have any difficulty reading these instructions for use (e.g. due to the font size), you can always download the current version of these instructions for use as a PDF document from the aks website<sup>1</sup>. Open the PDF document and adjust the display on your screen according to your needs.

This product is not permitted for use in the **United States of America** or **Canada**. The distribution and use of the product in these countries, including any distribution or use by third parties, is prohibited by the manufacturer.

1



You can find the latest version of the instructions for use in the download area on the aks website.

The **aks-SB L** homecare bed (also referred to in the following as the product/products) meets the requirements of modern homecare beds and is part of our range of heavy-duty beds. These are specifically designed for obese patients who cannot be cared for in a conventional homecare bed. Thanks to its homely wood trim, the homecare bed is easy to integrate into an existing living ambience.







Among other things, the product distinguishes itself through the following features:

- Patient weight up to 150 kg
- Safe working load of 190 kg
- The bed provides safety and reduces power consumption thanks to its mains power cut-off which only makes a connection to the mains supply when the manual control unit is operated.
- Motorised height and back part adjustment
- Homelike ambience thanks to wooden trim
- Uplifter with grab handle and sling (included)
- Integrated wood side rails
- Individually lockable castors
- Patented adjustment of thigh and lower leg part using the manual control unit by the patient without manual lifting of the lower leg part






We hope the product fulfils your expectations and wish you every success in caring for your patients.

### 1.1 Explanation of the symbols used

For ease of reading, these instructions for use employ the following symbols to indicate important information:

	<b>Warning of danger</b> Indicates safety instructions that must be observed under all circumstances in order to avoid an immediate danger to life and limb (risk of serious or fatal injury).
	<b>Warning of hand injuries</b> Indicates safety instructions for avoiding crushing injuries.
	<b>Warning of dangerous electrical voltage</b> Indicates safety instructions that must be observed in order to avoid danger through electrical voltage that may result in serious or fatal injury.
	<b>Keep dry</b> Keep away from spray water and do not use high-pressure jet cleaners.
	<b>Safety notice</b> Indicates information concerning safe use of and safe work on the product.
	<b>Information</b> Indicates useful and important instructions and information.

In these instructions for use, the following symbols, amongst others, are used to label medical devices:

	Observe instructions for use
	Production batch number, batch
	Article number
	Serial number
	Dimensions of the product

For more information on labelling, please refer to the chapter on **Product labelling**.

## 2 Intended use

The products are Class I active medical devices according to Regulation (EU) 2017/745, Annex VIII.

They have been tested for application environments 3 and 4 of the standard EN 60601-2-52, and are therefore suitable both for long-term care in a medical sector (e.g. old people's homes and care homes, rehabilitation facilities, geriatric facilities) and for domestic care. The products are only suitable for use in dry, indoor areas.



Refer to the rating plate or the chapter on **Technical data** for the permissible patient weight/working load.

See the chapter on **Technical data** for the climatic conditions.

The products are suitable for reuse (see chapter on **Reuse**). Intended use further includes reading and observing these instructions for use as well as performing the inspections and maintenance tasks in accordance with the maintenance schedule (see the chapter on **Maintenance**).

### 2.1 Intended purpose

The intended purpose of the products is sleeping/resting. They are used for alleviation of or compensation for an injury, disability or illness and offer a convenient solution for making the working conditions easier for the carer.

The products are intended for long-term use under normal conditions.



**Read and observe the instructions for use. Only use the product in accordance with the intended purpose as described. Any other use is forbidden.**



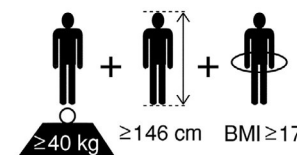
### 2.2 Indication

The product is intended for patients who, due to an illness, injury, disability or their age, suffer from reduced mobility. It aids the patient in their day-to-day life and the user in their work as a carer, and can thus help to maintain their health.

### 2.3 Contraindication



The product is only suitable for adult patients with a body weight of at least 40 kg, a height of at least 146 cm, and a body mass index<sup>1</sup> (BMI) equal to or higher than 17.



**Please note: due to the proportions of their bodies, some patients will be more prone to wedging (e.g. patients who are severely underweight or have undergone amputations).**

### 2.4 Side effects

There are currently no known side effects.

<sup>1</sup> Body mass index is a measurement of a person's outline based on their individual body weight and height:

$$BMI = \frac{\text{Weight (in kg)}}{\text{Size x size (in m)}}$$

### 3 Safety instructions



The safety instructions apply to all and any persons who perform work in any way with or on the product (incl. accessories). Where a specific group is addressed, this does not exclude any other persons.

Read and observe the safety instructions. The safety instructions comprise text or a combination of a symbol with text. The symbols used are not substitutes for the text for the safety instructions. Read the text of the safety instructions and follow it precisely.

#### 3.1 Explanation of the groups referred to

**The operator** is the person who is in possession of the medical device, i.e. any natural or legal entity whose employees operate/use the medical device. The operator does not necessarily need to be the proprietor of the medical device (e.g. medical supply store, authorised dealer, health insurer). The operator bears principal responsibility for the organisational measures and for ensuring compliance with national regulations.



The user must be trained in the safe handling of the medical devices described in these instructions for use (incl. accessories) prior to their first use and every reuse. **It is the duty of the operator (e.g. the responsible medical supply store/authorised dealer) to ensure that the user receives the proper training.**

If the medical device is to be used by relatives of the patient who are responsible for the patient's care<sup>1</sup>, the operator must inform said relatives of the circumstances in which they should ask a health care professional for advice, e.g.:

- If they observe any health problems in the patient that are associated with the product (incl. accessories).
- If they are unsure regarding a potential use of the product (incl. accessories).

In Germany, the EU Medical Devices Adaptation Act (MPEUAnpG) applies, and in particular the Medical Devices Implementation Act (MPDG) and the Medical Devices Operator Ordinance (MPBetreibV) contained in Article 1. The corresponding national laws, regulations and requirements are applicable in other countries.

**Qualified personnel** are persons who, through their training and practical activities, possess the required specialist knowledge and means to properly maintain [assemble, perform commissioning, maintain, inspect, repair, treat (clean/disinfect) and dispose of] medical devices – those defined in these instructions for use – (incl. accessories) and who are capable of performing and documenting the required tasks within the necessary scope.

---

1 Relatives who care for the patient do **not** usually possess formal health care training.



**Qualified electricians** as defined in the German accident prevention regulations DGUV Specification 3; persons who, through their specialist training, skills and knowledge as well as through knowledge of the valid regulations, are capable of performing the assigned work and assessing potential hazards.

The qualified electrician must further be trained in handling medical devices and possess knowledge of the specific product.

**Electrically instructed persons** are persons who have been instructed and, if necessary, trained by a qualified electrician regarding their assigned tasks and the possible hazards in the event of improper behaviour, as well as regarding the necessary safety equipment and safety measures.

In the context of these instructions for use, the word **user** refers to the person who uses (operates) the medical device (incl. accessories) on the patient. The user will be taught the skills and knowledge required to do this by means of proper training in the use of the product provided by the operator, in accordance with these instructions for use.



The user must be physically and mentally able to perform the following activities in relation to the medical devices (incl. accessories) described in these instructions for use:

- Use them in accordance with their intended purpose
- Set them up in accordance with their intended purpose (e.g. carry out permissible adaptations/modifications in line with the intended use and perform the permissible combinations)
- In case of unusual noises or obvious damage: shut them down, mark them clearly as “Out of order” and inform the appropriate qualified personnel

Users must be able to assess the patient’s clinical condition and to take specific action to protect the patient from danger. If relatives take over responsibility for the patient’s care, these relatives must be in a position to consult a health care professional when in doubt.

Prior to each use of the medical devices (incl. accessories) described in these instructions for use, the user must ensure that the products are in good condition and full working order, and observe the instructions for use.

In these instructions for use, the term **patient** is used to refer to a person who requires care due to their illness, injuries, disability or age.

For the sake of better legibility, only the male form (he/his) is used in the texts . The female form is of course always implicit in such use.

## 3.2 General safety instructions



**Training is required in the proper handling of the product (incl. accessories). The training must be documented in an appropriate form.** The training must be conducted on the product itself in accordance with the instructions for use, and must observe all the contents of said instructions for use.

**Note the permissible safe working load** (see chapter on **Technical data**). The max. permissible patient weight may be reduced by simultaneously added accessories (mattresses, anti-decubitus systems, cushioning etc.).

**Do not use a damaged or severely worn product/accessory.** Failure to observe this requirement may result in severe or even fatal injury to the patient.

**In addition to the periodic checking by suitable qualified personnel, check that the product and its accessories are in a safe state before each use** (see chapter on Maintenance, section **Maintenance schedule: Inspection by the user**). Do not continue using the product (including accessories) if you notice unusual noises or damage. Disconnect the product from the mains supply by pulling the mains power plug. If you have any doubts about the safety of the product or the accessories, do not use them. Mark the product/accessories clearly as "out of order" and inform your authorised dealer immediately.

**Observe the specifications regarding cleaning/disinfecting** (see the chapter on **Cleaning/disinfecting**).

**When cleaning/disinfecting the product, note that the individual components could be infectious or contaminated. Take suitable precautions for your own safety. Use suitable packaging/labelling to ensure that the product/accessories can be transported without any risk to third parties.**

**Keep the product (including accessories) away from direct sunlight. Protect the product from intense heat** (e.g. heating, stoves) **or open flames** (e.g. fireplace, cigarette ember, candle) **and other heat effects.** There is a risk of fire.

**Note that smoking in bed increases the risk of fire** (due to embers).

**Protect the product (incl. accessories) from pointed and sharp-edged objects and surfaces** (this also includes the claws and teeth of pets). There is a risk of damage.

Check the suitability of the product (incl. accessories) for the patient at regular intervals (e.g. in case of weight gain/loss). In doing so, take account of the special characteristics of the patient. Match the functional characteristics of the homecare bed to the specific disabilities and functional limitations of the respective patient. Potential contraindications must be observed in this regard.

Use the product (incl. accessories) in line with its intended purpose only and always observe the instructions for use.



Explain any potential risks to the patient and brief them to ensure that their behaviour does not generate any additional risks. There is a higher risk for unsupervised persons lying in the homecare bed who are also mentally deranged or extremely fragile. Strictly comply with the safety instructions specified here in order to minimise the residual risk. It may be necessary to lock the manual control unit (see the section on the **Manual control unit** in the chapter on Operation).



Use only original aks accessories/spare parts in order to avoid danger (see the chapter on **Accessories/combinations**).

Do not leave children unsupervised in the vicinity of the product. If necessary, remove the mains plug from the mains socket and block the manual control unit against unauthorised operation (see the section on **Manual operation** in the chapter on Operation). The product is not a toy.

If the product is not used for an extended period, observe the requirements for storage in the chapter on **Storage**.

Faults due to the use of mobile communications devices cannot be completely ruled out. Note that possible electromagnetic or other influences between the product and other equipment cannot be ruled out. If there is a risk of interference, remove the interference sources or do not use the product. When using mobile communications equipment, maintain a safety distance of at least 3.3 m. This avoids any potential electromagnetic interference between the communications devices and product and guarantees safe operation of the product. – See position paper of the German Federal Institute for Drugs and Medical Devices (BfArM) (reference no.: 9/0508).



The product's electrical components have been tested by an external, independent test institute to ensure the safety of the product. Nevertheless, hazards may arise in case of unintended use.

The product's electrical components have protection type IPX4; this must be maintained throughout the entirety of the product's life cycle. If an electrical component is damaged, the protection type will no longer apply. In such cases, the defective electrical component must be replaced immediately. Cease use of the product and mark it clearly as "Out of order". Inform your authorised dealer immediately. Failure to observe these requirements may result in moisture/liquid getting into the product. There is a risk of short circuit due to contact with moisture/liquids.



If you experience any serious incidents<sup>2</sup> involving the product (incl. accessories), please contact aks GmbH and the relevant national authorities without delay.

---

2 "Serious incident" means any incident (involving the product (or its accessories) that directly or indirectly led, might have led or might lead to any of the following: (the death of a patient, user or other person, or the temporary or permanent serious deterioration of a patient's, user's or other person's state of health).

### 3.3 Safety instructions for the operator



**Prior to initial use and every reuse, train the user on the product itself (incl. accessories) on the basis of the instructions for use, explain the safety instructions, test the effectiveness of the training, and properly document said training. Make the user aware of the hazards that may arise in case of unintended use of the product (incl. accessories).**

**The product is not EX-protected and must not be operated in potentially explosive areas.** It must not be operated in the vicinity of flammable, narcotic mixtures of air, oxygen or nitrogen oxides.

**The product does not have any equipotential bonding and is therefore not suitable for medical electrical applications.**

**Instruct the user that checks must be performed to ensure that no children and/or pets have crept underneath the product before lowering it (risk of getting trapped).** When raising or lowering the product, ensure that there is sufficient clearance to other objects such as walls, window sills, plug sockets, ceiling lamps etc.

**Instruct the user that the bed surface needs to be moved to its lowest position if the patient is going to be left unsupervised.** This reduces the risk of injury from falling when getting in and out of the bed or from falling off the bed.



**You as the operator must ensure (e.g. by means of corresponding instructions and precautions) that no mechanical loads are applied to the power cable during charging (e.g. kinking, shearing, driving over the cables with the product itself or with equipment trolleys, loads during room cleaning etc.).**

**Make sure that the electrical installation of the room/area in which the product is connected and operated complies with the state of the art.**



Only allow suitable qualified personnel to perform the assembly, commissioning, maintenance, treatment (cleaning/disinfecting) and repair of the product (incl. accessories).

Make sure that the user is physically and mentally able to perform the following activities in relation to the medical devices (incl. accessories) described in these instructions for use:

- Use them in accordance with their intended purpose
- Set them up in accordance with their intended purpose (e.g. carry out permissible adaptations/modifications in line with the intended use and perform the permissible combinations)
- In case of unusual noises or obvious damage: shut them down, mark them clearly as "Out of order" and inform the appropriate qualified personnel



Inform the user that, in addition to the periodic checking by suitable qualified personnel, the user themselves must check that the product and its accessories are in a safe state before each use (see chapter on Maintenance, section **Maintenance schedule: Inspection by the user**).

Make sure that the user possesses the skills and knowledge required to check the suitability of the product (incl. accessories), to assess the patient's clinical condition, and to take specific action to protect the patient from danger.

Observe the following measures in order to prevent fires:

- Use flame-retardant mattresses and bedsheets wherever possible.
- Instruct the user and the patient that smoking in bed is not allowed.
- Instruct the user and the patient that candles are not allowed next to the bed.
- Only use electrical devices (e.g. lamps, radios) that are in full technical working order, and ensure that their power cables are not in a position where they can be damaged by the moving parts of the care bed.
- Make sure that these devices cannot accidentally end up on or under the bedsheets (risk of heat accumulation). Use LED lamps where possible, as these generate far less heat than conventional lamps.
- Do not connect plugs to extension cables or multiple sockets underneath the bed (risk of short-circuit/fire due to penetration by water).

If relatives take over responsibility for the patient's care, check that these relatives are in a position to consult a health care professional when in doubt. Explain to the users when they should ask a health care professional for advice, e.g.:

- If they observe any health problems in the patient that are associated with the product/accessories.
- If they are unsure regarding a potential use of the product/accessories.

Use only original drive components in order to avoid danger. Never use drive components produced by other drive manufacturers. Never create systems comprising a mixture of different brands (see chapter on Technical data, section **Electrical data!**)



When using the product, comply with all the provisions of the EU Medical Devices Adaptation Act (MPEUAnpG), and in particular the Medical Devices Implementation Act (MPDG) contained in Article 1, and all additionally applicable legal regulations as well as with the applicable work health and safety regulations, accident prevention regulations and the general provisions concerning the handling of technical devices.

Note that this product is a medical device and the Medical Devices Operator Ordinance (MPBetreibV) are binding for the operator in Germany.

The corresponding national regulations apply in other countries. For use in countries other than Germany, observe the respective applicable national laws, regulations and provisions.

### 3.4 Safety instructions for the user



Arrange for the operator (e.g. your responsible medical supply store/authorised dealer) to train you in the safe handling of the product (incl. accessories) using the product itself, in accordance with the instructions for use.

**Only use the product (incl. accessories) if you have been instructed about its handling – including the safety instructions – and you have the corresponding expert knowledge to assess the suitability of the product (incl. accessories) for the patient.** If in doubt, ask a health care professional for advice. If you have queries, particularly regarding the safety instructions, please contact the operator. **Do not use the product (incl. accessories) until all matters have been clarified. This is to prevent injuries and damage due to incorrect use.**



Prior to each use of the medical devices (incl. accessories) described in these instructions for use, ensure that the products (incl. accessories) are in good condition and full working order (see chapter on Maintenance, section **Maintenance schedule: Inspection by the user**). Observe the instructions for use.

Observe the max. permissible on-time. If this is exceeded, safe operation can no longer be guaranteed (see the chapters on **Commissioning** and on **Technical data**).

## 4 Scope of delivery

The product has already been inspected at the factory to ensure completeness and freedom from defects. Nevertheless, check the product immediately after receipt for possible transport damage.

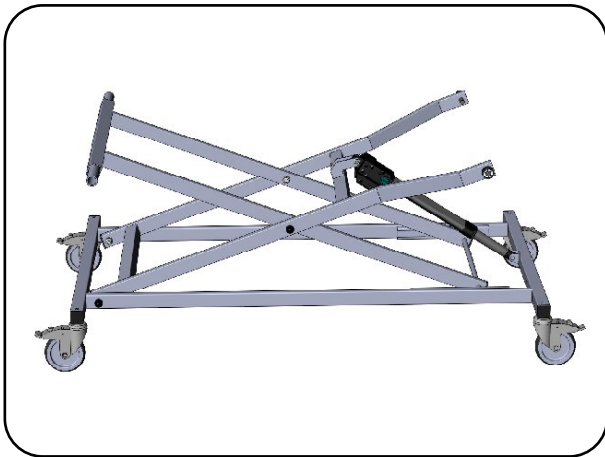
After removing all individual parts, check the completeness of the scope of delivery using the delivery note. If not all the individual parts of the scope of delivery are present, contact your authorised dealer.

The product's scope of delivery includes:

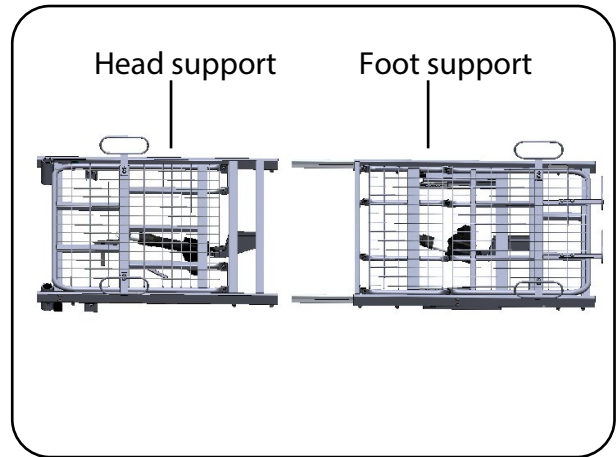
### Delivery in cardboard box

Scope of delivery	Card-board box	Contents
<b>Scissor lift</b>	SH	<ul style="list-style-type: none"> <li>1 Scissor lift (Fig. 4.01)</li> <li>1 Cardboard box with (Fig. 4.11):               <ul style="list-style-type: none"> <li>1 Mains adapter with integrated controller</li> <li>1 Mains plug incl. mains power cut-off</li> <li>1 Manual control unit including lock key</li> </ul> </li> <li>1 Bag with (Fig. 4.12):               <ul style="list-style-type: none"> <li>1 Instructions for use</li> <li>1 Allen key 6 mm</li> <li>1 Transport lock</li> </ul> </li> </ul> <p style="margin-left: 40px;">up to 100 cm bed surface width      from 120 cm bed surface width</p> <ul style="list-style-type: none"> <li>12 Cylinder head bolts, M8x45 (Fig. 4.06)</li> <li>4 Cylinder head bolts, M8x20 (Fig. 4.08)</li> <li>8 Cylinder head bolts, M8x50 (Fig. 4.08)</li> </ul>
<b>Bed surface</b>	KA	<ul style="list-style-type: none"> <li>1 Head support (Fig. 4.02)</li> <li>2 M8x16 cylinder head bolts (pre-assembled)</li> </ul>
	FA	<ul style="list-style-type: none"> <li>1 Foot support (Fig. 4.02)</li> <li>2 Extension tubes (connected to the frame) (Fig. 4.05)/(Fig. 4.07)</li> </ul>
<b>End panels</b>	SP	<ul style="list-style-type: none"> <li>2 End panels (Fig. 4.03)</li> </ul>
<b>Uplifter</b>	A	<ul style="list-style-type: none"> <li>1 Uplifter (Fig. 4.09)/(Fig. 4.10) (from 120 cm bed surface width: square tube cross section)</li> <li>1 Grab handle with strap</li> </ul>
<b>Side bars</b>	HSG	<ul style="list-style-type: none"> <li>1 Wood side bar slats (Fig. 4.04)</li> <li>2 Side bar slat, 110 mm</li> <li>2 Side bar slat, 90 mm</li> </ul>

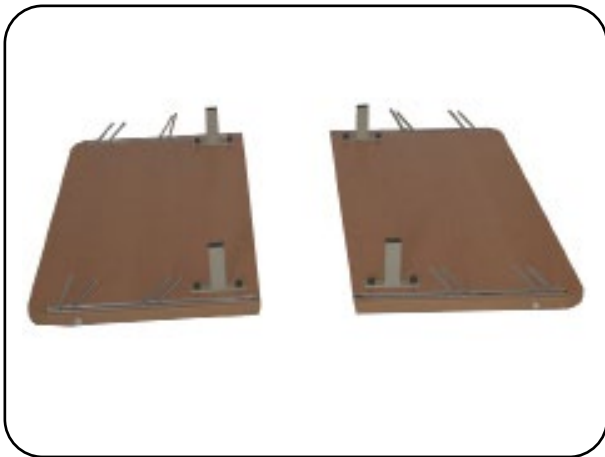




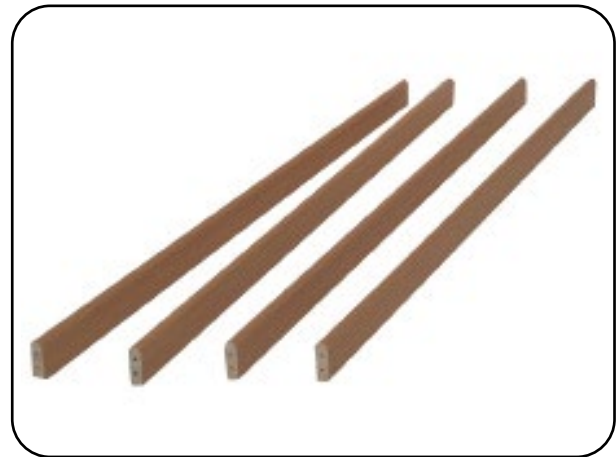
**Fig. 4.01 - Scissor lift (SH)**



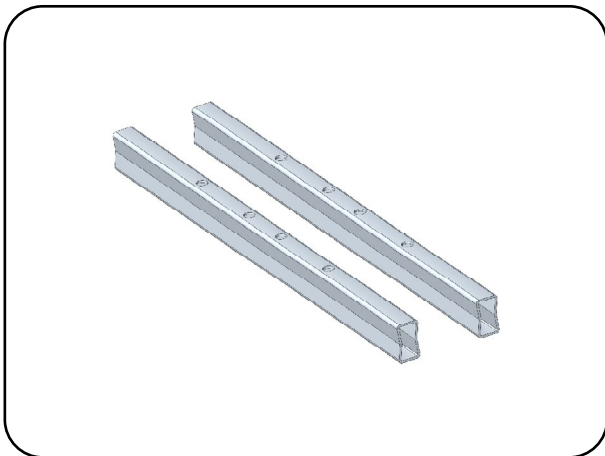
**Fig. 4.02 - Head support (KA)  
and foot support (FA)**



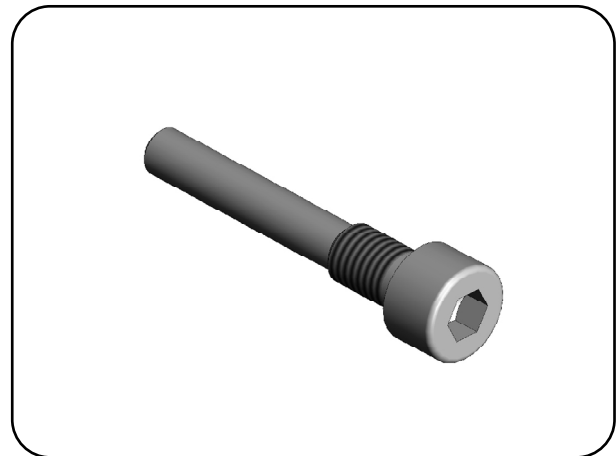
**Fig. 4.03 - End panels (SP)**



**Fig. 4.04 - Wood side bar slats (HSG)**

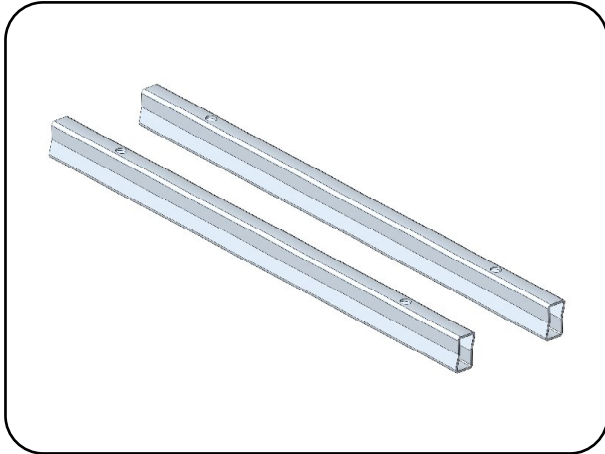


**Fig. 4.05 - Extension tubes  
(up to 100 cm bed surface width)**

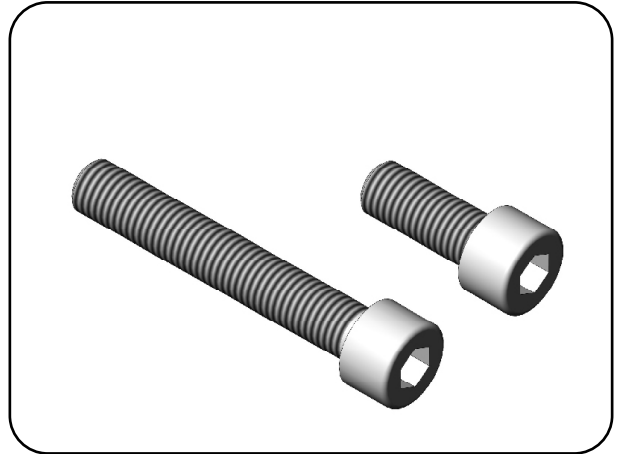


**Fig. 4.06 - M8x45 cylinder head bolt  
(up to 100 cm bed surface width)**





**Fig. 4.07 – Extension tubes  
(from 120 cm bed surface width)**

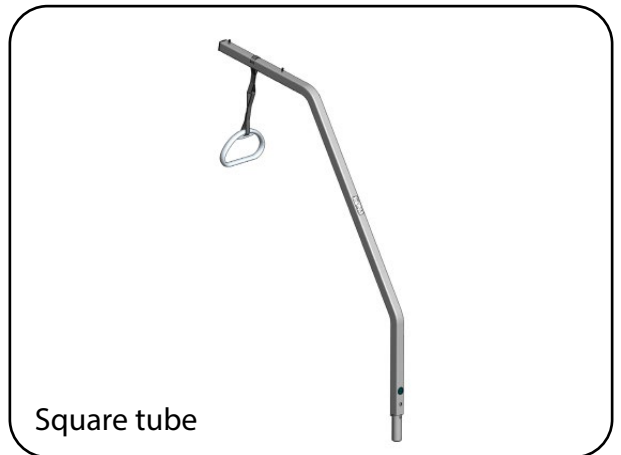


**Fig. 4.08 – Cylinder head bolts,  
M8x20 and M8x50  
(from 120 cm bed surface width)**



Round tube

**Fig. 4.09 – Uplifter with grab handle and strap  
(up to 100 cm bed surface width)**



Square tube

**Fig. 4.10 – Uplifter with grab handle and strap  
(from 120 cm bed surface width)**



**Fig. 4.11 – Mains adapter with integrated  
controller, mains plug incl. mains power cut-off  
and manual control unit incl. lock key**



**Fig. 4.12– Instructions for use, Allen key and  
transport lock**

5 Product overview

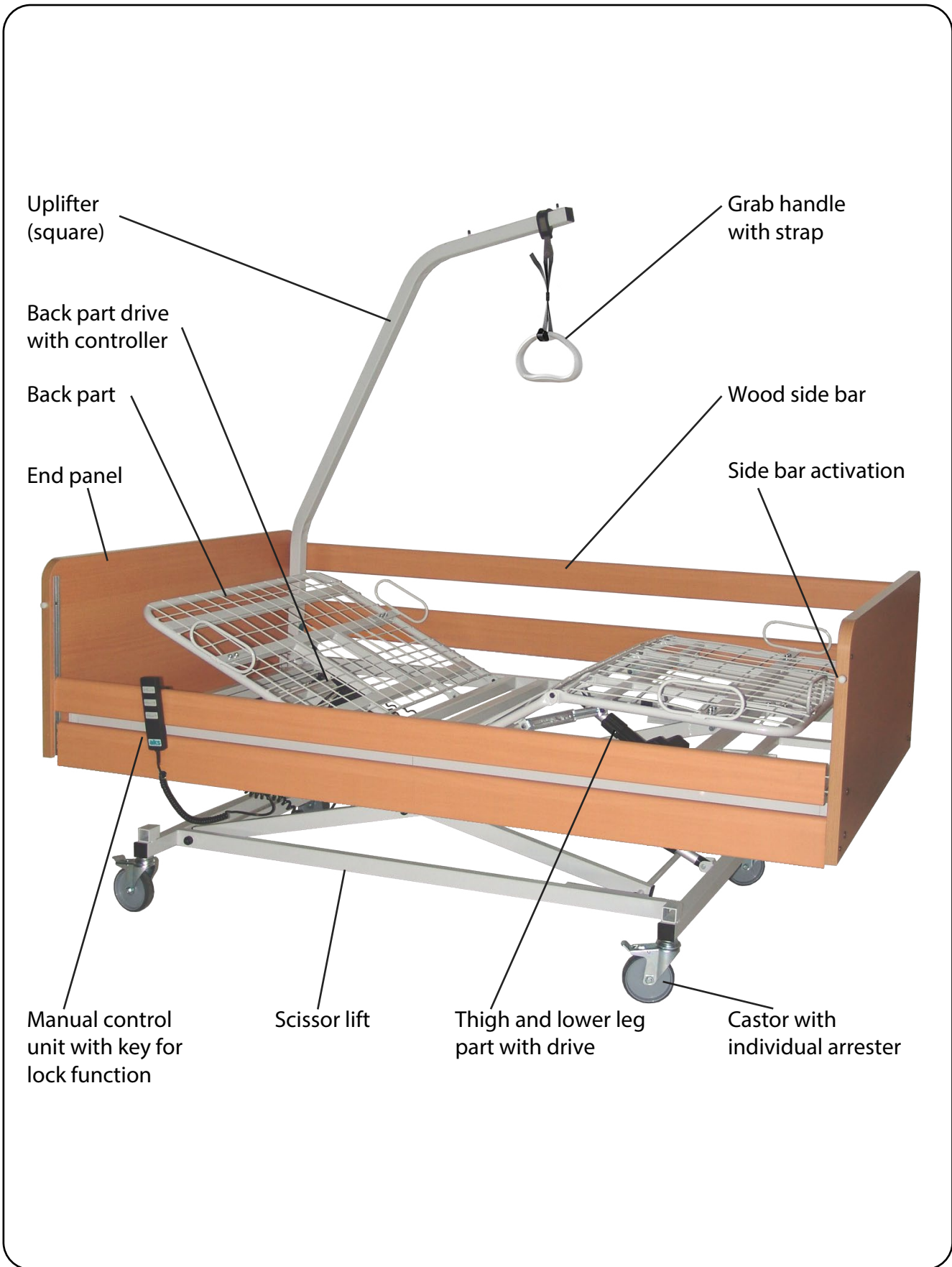


Fig. 5.01 – aks-SB L,  
version from 120 cm bed surface width

## 6 Assembly

Assemble and dismantle the product according to the specifications in these instructions for use. Observe the safety instructions and use protective materials placed on the ground (e.g. cardboard/ packaging material) to prevent damage to the flooring. In addition to the supplied 6 mm Allen key, you also need a Phillips screwdriver and a side cutter for the assembly.

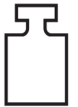


**The mains plug must not be connected to the mains supply during the assembly.**



Inspect the product before and during assembly for damage and defects.

During assembly/dismantling, note that the individual parts can weigh more than 20 kg! The relevant parts are marked with the adjacent symbol.



Keep the original packaging for possible transport or storage in the future.

## 6.1 Assembling the homecare bed

If you have established that the delivery is complete and undamaged based on the chapter on **Scope of delivery**, proceed as follows to set up the product:

1. Place the scissor lift with the castors on the floor and brake the castors (see chapter on Operation, section **Castors**) (Fig. 6.1.01).
2. Temporarily connect the drive of the scissor lift and the manual control unit to the mains adapter. The power supply can be earthed while you do this.
3. Move the scissor lift to its top position. Note that the manual control unit may need to be unlocked beforehand (see chapter on operation, section **Lock function**).
4. Then disconnect the mains adapter from the drive and put it aside.
5. Remove the two M8 x 16 cylinder head bolts with spring washer on the side of the support mountings for the head support (Fig. 6.1.02).

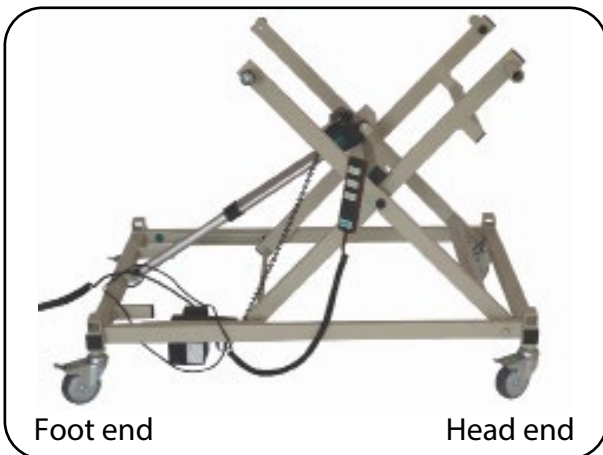


Fig. 6.1.01 – Scissor lift in top position



Fig. 6.1.02 – Support mounting for head support

6. Place the head support with the support mountings on the side round tubes of the scissor lift (Fig. 6.1.03). To facilitate assembly, place the assembly tool (with the large fork opening facing down) centrally between the cross tubes of the scissor lift and the head support (Fig. 6.1.03 and Fig. 6.1.04). The head support is now horizontal. Alternatively, a second person can hold the head support in a horizontal position.



The assembly tool – not included in the scope of delivery of the product – is available as an accessory (see chapter on **Accessories/combinations**).



Fig. 6.1.03 – Head support attached

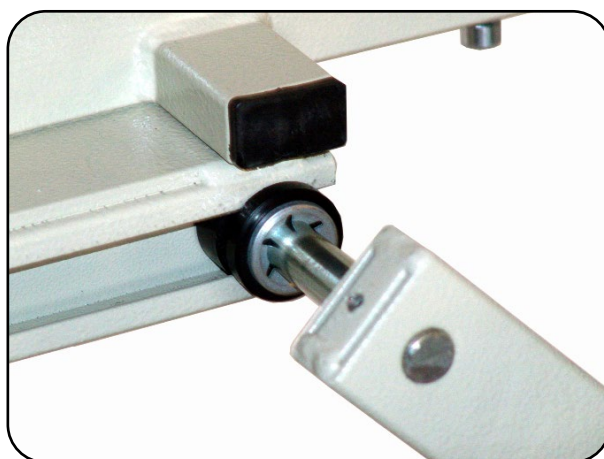


Fig. 6.1.04 – Assembly tool

7. To fasten the head support in place, tightly screw in the two M8 x 16 cylinder head bolts with spring washer into the support lugs on the side (Fig. 6.1.02).
8. Detach the extension tubes that were fastened to the foot support with cable ties for the transport.
9. Insert these in the extension tubes into the longitudinal tubes of the head support Only fix the extension tubes loosely with two M8 x 45 cylinder head bolts each (*for the 120 cm bed surface width and more version: M8 x 20 and M8x50*) in each case so that they can be moved for assembly (Fig. 6.1.05).
10. Slide the foot support onto the extension tubes and as you slide it on, thread the castors into the C-rail (Fig. 6.1.06).



**Fig. 6.1.05 – Extension tubes in the longitudinal tubes of the head support**



**Fig. 6.1.06 – Castor in the C-rail**

11. Remove the assembly tool by folding it to the side and pulling it out.
12. Screw all M8 x 45 Allen keys tight (*for the 120 cm bed surface width and more version: M8 x 20 and M8x50*) with the enclosed Allen key (6 mm) to the connecting points for the bed surface (Fig. 6.1.07).
13. Remove the cable ties (transport lock) on the head support and foot support.
14. Now assemble the controller as described in the chapter on Assembly, section **Assembling the controller**.



**Fig. 6.1.07 – Head and foot supports installed**

15. Insert an end panel in the longitudinal tubes at the head or foot end of the bed surface. Fasten the end panel with the two M8 x 45 cylinder head bolts (*for the 120 cm bed surface width and more version: M8x50*).
16. Slide the side bar slats onto the guide pins for the side bar sliders and place the side bar slats onto the bed surface (Fig. 6.1.08). When assembling the side bar slats, make sure that the top slats are 90 mm high and the lower slats are 110 mm high. The different diameters of the drilled holes and the pins prevents the side bar slats being installed in the wrong locations.
17. Push the second end panel at the end that it is still free into the longitudinal tubes, but only far enough for the end panel to stay in place.
18. Now lightly attach the lower side bar slats (110 mm high) to the guide pins of the side bar sliders.
19. Push the end panel further until you can also attach the upper side bar slat (90 mm high) to the guide pins.
20. Then insert the end panel as far as the stop and fasten it using two M8 x 45 cylinder head bolts (*for the 120 cm bed surface width and more version: M8x50*). Check that the side bars function correctly.
21. For commissioning of the care bed, proceed as described in the chapter on **Commissioning**.



**Fig. 6.1.08 – Guide pins for side bar sliders**



## 6.2 Assembling the controller

1. Slide the controller onto the back part drive. Secure the controller against slipping away using the fixing screw (Fig. 6.2.01).
2. Press the strain relief of the power cable into the holder on the head end (Fig. 6.2.02).



Fig. 6.2.01 – Controller on back part drive



Fig. 6.2.02 – Strain relief in holder

3. Connect the manual control unit (H) to the controller and secure its power supply line with the strain relief (Z) according to Fig. 6.2.03.



Ensure the power cable of the manual control unit is fastened to the strain relief Z, otherwise damage/breaks can occur at the plug connection.

4. Plug in the drives as shown in Fig. 6.2.03.

- H = connection for manual control unit
- 1 = connection for back part drive
- 2 = connection for thigh part drive
- 3 = connection for height adjustment drive in the scissor lift
- 4 = Dummy plug
- Z = Strain relief for manual control unit power cable



Fig. 6.2.03 – Controller



**Do not operate the controller with uncovered sockets!** All sockets must have either an electrical plug or a dummy plug plugged into them. There is a risk of short circuit or fire due to contact with moisture/liquids.

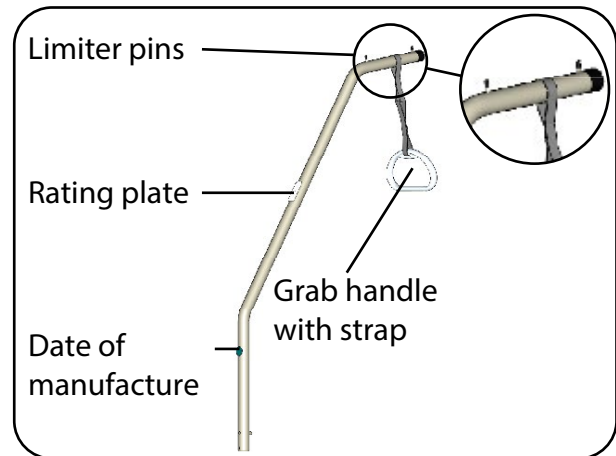
### 6.3 Assembling the uplifter and grab handle

The uplifter should be mounted on the side of the homecare bed that the patient uses to get in and out of bed.

1. For easier assembly of the uplifter, lower the homecare bed.
2. Insert the uplifter into one of the head end receptacles on either the left or right (Fig. 6.3.01). Ensure that the pin of the uplifter is completely inserted in the notching of the uplifter mounting.
3. Insert the transport lock into the free uplifter socket. See also the chapter on **Patient transport**.

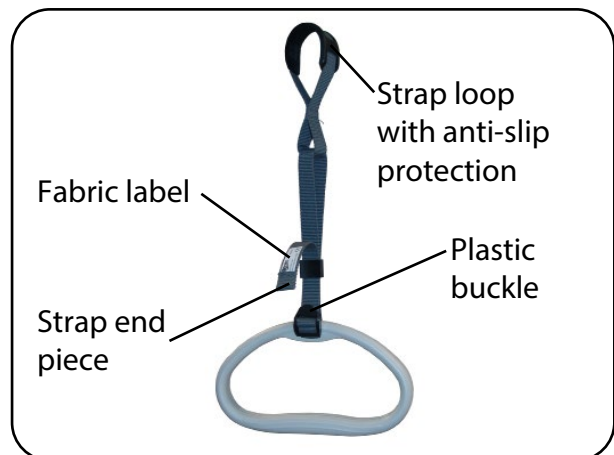


**Fig. 6.3.01 – Uplifter mountings for uplifter (shown here: round tube) and transport lock**



**Fig. 6.3.02 – Uplifter (shown here: round tube) with grab handle and strap**

4. Position the strap's loop between the two limiter pins on the uplifter (Fig. 6.3.02).
5. Adjust the height of the grab handle to the patient's individual needs. The strap can be adjusted in a range of 20 cm using a plastic buckle (Fig. 6.3.03). When doing so, make sure that no weight is applied to the handle. Make sure that the strap's end piece is at least 3 cm above the plastic buckle (Fig. 6.3.03).
6. Check that the grab handle is firmly attached by carefully pulling it downwards.



**Fig. 6.3.03 – Grab handle with strap**



## 7 Commissioning

Before using the product for the first time and every time it is reused, check that the product (incl. accessories) is in safe condition based on the maintenance information in the chapter on **Maintenance**. Before the product (incl. accessories) is reused, always clean and disinfect it in accordance with the instructions given in the chapter on **Cleaning/disinfecting**.



Observe the safety instructions (see chapter on **Safety instructions**).

Only use the product with a suitable mattress whose bed surface fits the dimensions of the bed.

The motorised adjustment is not suitable for continuous operation. The maximum on-time of two minutes must not be exceeded. Once the product has been operated continuously for the maximum on-time, it must remain switched off for at least 12 minutes. Exceeding the max. on-time shortens the product's service life.



**When positioning the product, make sure it has sufficient clearance from other objects such as walls, sloped ceilings, window sills and power sockets, and also from ceiling lamps. Make sure there are no objects under the bed.**



Keep the product away from direct sunlight, fire and heat sources (e.g. heating, stoves etc.).

In order to counteract any overload of the electrical components, the control unit is fitted with a self-resetting fuse. If the on-time is exceeded or the minimum cooling time is not achieved, the overload protection automatically switches off the drive system. After an adequate cooling down phase, the overload protection automatically enables the drive system again.

Connect the product to the mains supply; connected load: see chapter on Technical data, section **Electrical data**. When connecting the product, make sure that the power cable cannot be dragged, driven over or endangered by moving parts when the product is operated.



**Check the power cable for damage. If this check reveals signs of defects/damage, cease use of the product.**

**Connect the mains plug** (see chapter on Operation, section **Mains power cut-off**) **directly to the mains supply. Only use mains sockets that have been installed properly and are suitable for use with the mains plug. Do not use a multiple socket. Ensure that the mains plug is always accessible so that the product can be disconnected from the mains supply in an emergency.**

**Do not operate the controller with uncovered sockets!** All sockets must have either an electrical plug or a dummy plug plugged into them. There is a risk of short circuit or fire due to contact with moisture/liquids.

## 8 Operation

The products (incl. accessories) have been developed for use with a suitable mattress. Before and, if applicable, during each use of the product, note the following information:



Inspect the product at regular intervals (see the section **Maintenance schedule: Inspection by the user** in the maintenance chapter).



**Do not use a damaged or severely worn product. Inspect the product in question (incl. accessories) for damage and defects before use.** Failure to observe this requirement will increase the risks associated with using the product.

**As the operator, you must train the user and make them aware of the hazards that may arise in case of unintended use of the product.**

Amongst other things, you must draw attention to the following hazards/risks:

- Before lowering the product, checks must be performed to ensure that no children and/or pets have crept underneath the homecare bed (risk of getting trapped).
- When using the side bars, there is an increased risk of crushing and shearing! When lowering the side bars, care must be taken to ensure that no extremities (e.g. fingers, hands) are within the lowering area.



**The electrical components must show no external signs of damage. In case of damage, fluids such as water and cleaning agents may get into the electrical components. This can cause malfunctions and damage to the electrical components. Do not use the components if they become damaged. Mark the product clearly as “out of order” and inform your authorised dealer immediately.**

**Note that protection against spray water (protection type/moisture protection) is only guaranteed when electrical and/or dummy plugs are plugged into all the sockets.**

### 8.1 Castors

The product is fitted with four individually lockable castors. The individual arresting enables you to arrest each castor individually and secure the product against accidentally rolling away.



When releasing/arresting the castors wear sturdy shoes without open toes in order to prevent injuries to your toes. Set the foot lever to the corresponding position to release or apply the brake (Fig. 8.1.01 and Fig. 8.1.02).

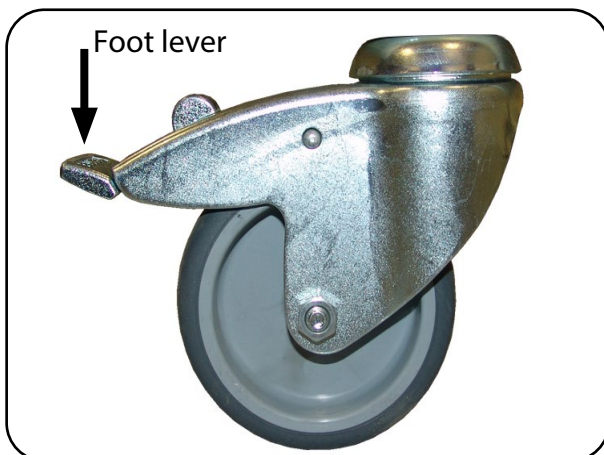


Fig. 8.1.01 – Castor released



Fig. 8.1.02 – Castor arrested



**Ensure that at least three of the castors are arrested at all times to prevent the product from accidentally rolling away. Do not use the product further if the locking devices / foot lever fail or spring open of their own accord.**



Every time you engage the arresters, check that the castors are locked and that they remain locked by attempting to move the product.

Before using the product on parquet/natural wood floors, check whether the floor sealant is suitable for preventing the castors from causing damage (e.g. discolouration). The product can generally be used on tiles, carpets, laminate flooring and linoleum without any problem, though care should be taken to ensure that any damage that does occur is noticed at an early stage. aks GmbH accepts no liability for damage arising from everyday use on floors.

## 8.2 Side bars



The use of the side bars must always match the particular requirements and needs of the patient and/or be indicated by the professional assessment of the care personnel. Please also observe the additional legal specifications that may apply, e.g. when using the product in an institution.



The risk of the patient accidentally falling from the product is reduced when using the side bars. However, the side bars are not suitable for preventing the patient from getting out of the bed deliberately.

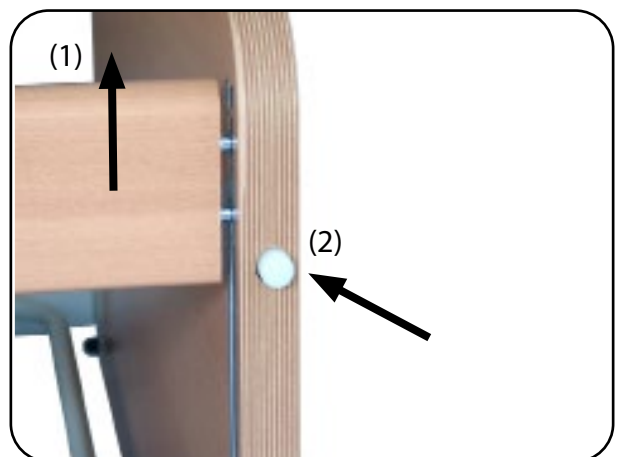
To operate the side bars, proceed as follows:

### Raising the side bars

In order to use the side bars, pull them up slowly by the top side bar slat on the head and foot end until the side bar sliders engage.

### Lowering the side bars

1. To lower the side bars, first raise the top side bar slat (1) to unlock the release button (Fig. 8.2.01).
2. Keep the release button (2) pressed while the top slat is still raised and, still keeping the button pressed, lower the side bar slat down past the locking mechanism. When doing so, always lower the side bars slowly and carefully (Fig. 8.2.01).



**Fig. 8.2.01 – Lowering the side bars**

Strictly observe the following safety instructions when using the side bars:



**When using the side bars, there is an increased risk of crushing and shearing! Take care when lowering the side bars that no extremities (e.g. fingers, hands) are within the lowering area.**



**Before every adjustment of the back part or thigh and lower leg part, ensure that no limbs of the patient are between the side bar slats.**

**When using the side bars, there is a general risk of wedging and falling out through too large gaps.**

**The side bars are intended to protect the patient from falling off the bed. They must not be leaned on or used as supports.**

**Therefore, the suitability of the side bars must be checked taking into account the characteristics of the respective patient, in particular the distances between slats and stays in relation to the physique of the patient. Please note: due to the proportions of their bodies, some patients will be more prone to wedging (e.g. patients who are severely underweight or have undergone amputations).**



Ensure that the side bar height from the top side of the mattress is at least 220 mm. If it is less than 220 mm, use the aks side bar height extender.

The side bars only provide protection against accidentally falling out if they are raised on both sides (head and foot end) and if the bed surface elements such as back, thigh and lower leg part are in the horizontal position.

Check the side bars for correct locking every time you raise them.

### 8.3 Uplifter

For a bed surface width of up to 100 cm, the standard uplifter is used. For a bed surface width of 120 cm or more, the longer, reinforced uplifter made of square tubes is used.

The uplifter with grab handle and strap (Fig. 8.3.01) is a useful aid which helps patients move in the homecare bed by themselves and encourages mobility. The standard position of the grab handle is above the centre of the homecare bed. It can be swivelled from the centre of the bed to the edge of the bed for safe access when getting into or out of the bed.



Do not swivel the uplifter outside the homecare bed. If you do so, there is a risk that the bed will tip over when the patient pulls on the uplifter. The pin of the uplifter must remain in the notching of the uplifter mounting at all times.



**When attached, the grab handle and strap must not be twisted around its vertical axis through more than 180°.**

**If the grab handle and/or strap are discernibly damaged, replace them immediately. Check for such damage during normal use in addition to regular maintenance, and at least every three months.**



According to the manufacturer, the grab handle has been designed for a service life of approx. 5 years as of first use. Improper use as well as a lack of care when handling it will accelerate ageing and contribute to increased wear.



The production date is a logical aid. It is shown on the fabric label sewn onto the strap (Fig. 8.3.02). In respect to regular checks/maintenance intervals as well as in respect to its recommended service life, the date of first use takes precedence.

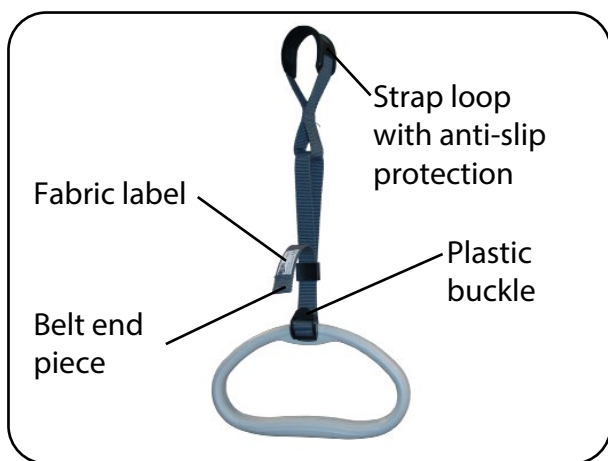


Fig. 8.3.01 – Grab handle with strap

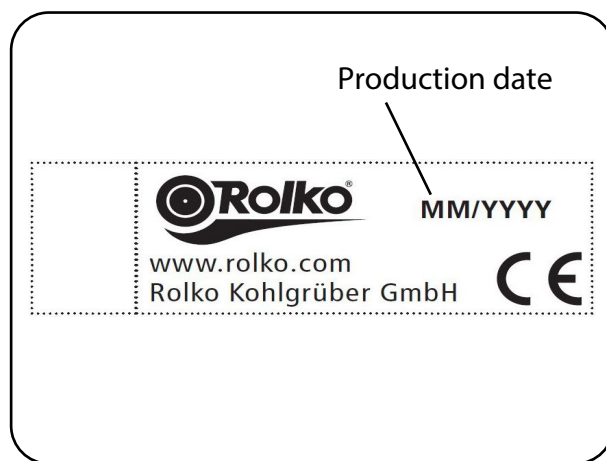


Fig. 8.3.02 – Fabric label



According to the manufacturer, careful handling together with observance of the recommended maintenance intervals will allow the grab handle to be used beyond its recommended service life. Please refer to the additionally applicable manufacturer documentation.



**Never exceed the uplifter’s safe working load of max. 80 kg.**

### 8.4 Bed surface

The homecare bed's bed surface is electrically adjustable. It consists of several elements, which are shown in Fig. 8.4.01.



When using alternating-pressure systems, observe the manufacturer's specifications, as positioning the bed surface at an angle may impair the alternating-pressure system's performance.

Please note: people must not be allowed to sit on any slightly raised elements of the bed surface (back, thigh or lower leg parts). Failure to observe this requirement may lead to hazards/damage.

The bed surface can be adjusted as follows (Fig. 8.4.02):

#### Bed surface height adjustment

The bed surface height can be continuously adjusted from 40 cm to 90 cm. When doing so, the castors must be braked.

For design reasons (scissor lift), the height adjustment range is affected by manufacturing tolerances and elasticities. Depending on the load case (attached accessories, patient weight etc.), deviations of up to 3 cm are possible.

#### Angular adjustment of the back part

The back part can be continuously adjusted from 0° to 70° (Fig. 8.4.02). The adjustment of the back part is independent from the adjustment of the thigh and lower leg parts.

#### Angular adjustment of the thigh part

The thigh part can be infinitely adjusted from 0° to 40° (Fig. 8.4.02). The lower leg part will move with the thigh part.

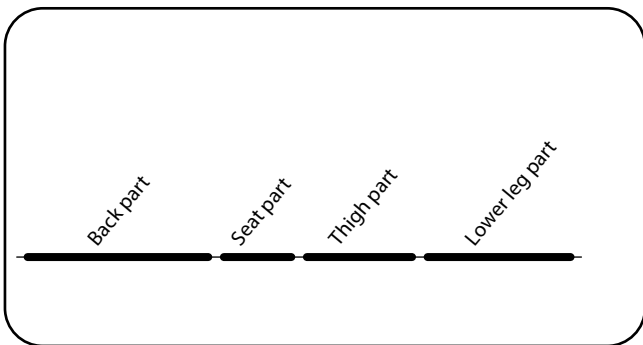


Fig. 8.4.01 – Bed surface elements

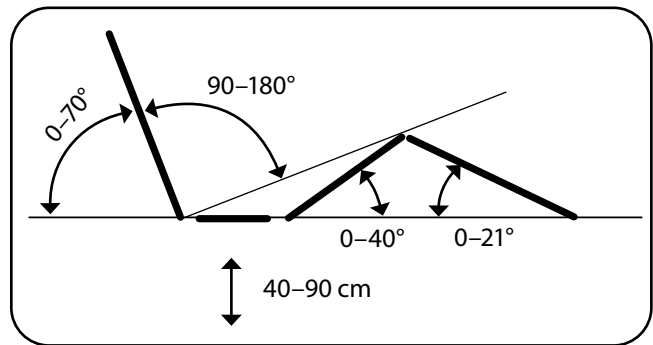


Fig. 8.4.02 – Bed surface adjustment options

#### Patented angular adjustment of the lower leg part

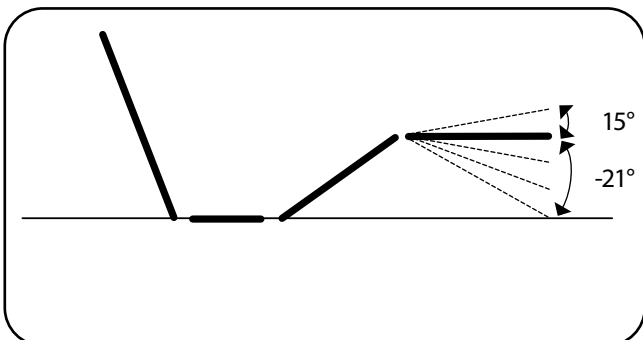


Fig. 8.4.03 – Additional adjustment options for the bed surface using the patented angle adjustment

The product is equipped with ratchet adjusters between the thigh and lower leg parts. These enable the patient to adjust the lower leg part (Fig. 8.4.03) using the manual control unit (without requiring help from care personnel). To do so, perform the following steps:

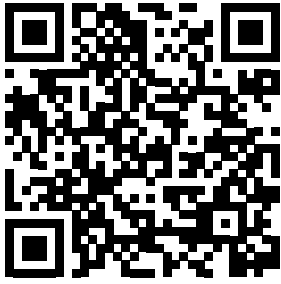


Fig. 8.4.04 – Instruction video

1. Move the thigh part completely up. In doing so, the lower leg part moves with it.
2. Now move the thigh part down again. Each of the four ratchet adjuster positions are moved to successively. Reaching each individual stage can be recognised by an audible click. Stop the thigh part at the required stage.
3. Now move the thigh part up again to the required position. The lower leg part is now at a certain angle to the thigh part. This angular setting is fixed by the ratchet adjuster.

To set a different angle between the thigh and lower leg parts, move the thigh part all the way to the horizontal position. The ratchet adjuster is then disengaged. The angle can now be set as described in steps 1 to 3.



When using patient hoists, the bed surface must be set to a horizontal position.

Depending on the floor covering, it may be expedient to release the castor brakes (see the section on the **Castors** in the chapter on Operation) at one end (head or foot end) to avoid damage.



### 8.5 Manual control unit

In order to perform the electrically powered functions, press the corresponding function button on the manual control unit until the desired position is reached (Fig. 8.5.01).



Note that only one function button may ever be used at any one time. Otherwise the electrical system can shut down and/or be damaged due to overload.

Collisions with other objects or equipment can lead to function buttons being pressed accidentally.

Take care to ensure that the manual control unit's power cable is not crushed, stretched or otherwise placed at risk of damage by the moving parts of the bed.

When the manual control unit is not in use, hang it onto its hook on the homecare bed, where it is in easy reach at all times. The manual control unit's keyboard should be facing the inside of the bed.

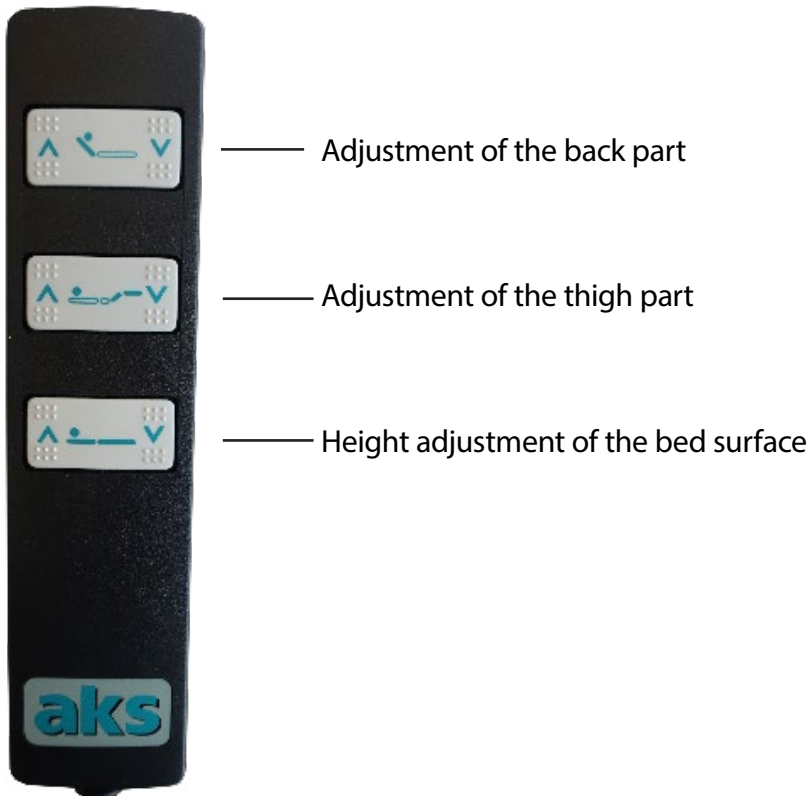
There is a rotary switch on the rear side of the manual control unit which is operated using the associated key. The rotary switch allows you to both lock functions (see the section on **Lock function** in the chapter on Operation) and to check the manual control unit's cable (see the **Maintenance schedule** in the chapter on Maintenance).



**When performing electric adjustments, make sure there is sufficient space for the respective movements. The adjustment range must be clear of objects and limbs. The adjustments may only be carried out by or in the presence of a person who possesses the required training.**



If the manual control unit is not locked, instruct the patient in its proper use.



**Fig. 8.5.01 – Manual control unit**



## 8.6 Lock function

The manual control unit is equipped with a lock function. This enables the user to disable the functions of the manual control unit using the corresponding key. There are many situations in which it is prudent to lock the manual control unit, for example:

- If the patient is unable to operate the bed safely or free themselves from dangerous positions
- If there is an increased risk of the patient becoming wedged when using the side bars and adjusting the back or thigh part of the bed
- If unintentional operation of the function buttons could place the patient at risk
- If children could gain unsupervised access to the homecare bed

To lock the manual control unit, insert the key (Fig. 8.6.01) into the rotary switch on the back of the manual control unit (Fig. 8.6.02). If an open padlock can be seen in the view window of the key (Fig. 8.6.03), the manual control unit is unlocked. If you can see a closed padlock, the manual control unit is locked. The rotary switch positions I and II are testing functions, and are used for checking the manual control unit's power cable (see the **Maintenance schedule** in the chapter on maintenance). The power cable is OK if the product does not react to manual control unit inputs in either switch position I or switch position II. Otherwise, the power cable and the manual control unit are defective and must be replaced by your authorised dealer.



**Test the lock function by pressing a button. If the bed is adjusted despite being locked, the manual control unit must be replaced.**



Do not leave the key in the manual control unit. The key must be kept in a secure location to prevent unauthorised persons from unlocking and enabling the functions.

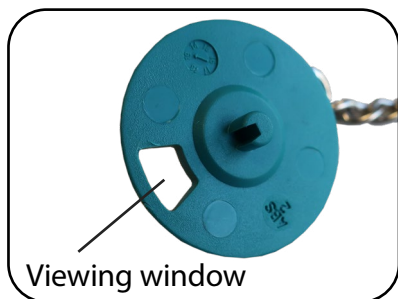


Fig. 8.6.01 – Key

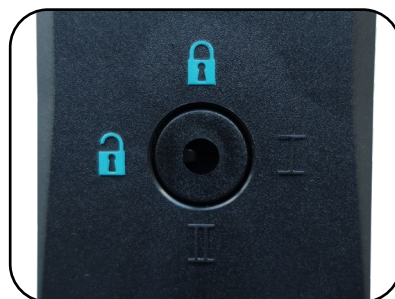


Fig. 8.6.02 – Rotary switch

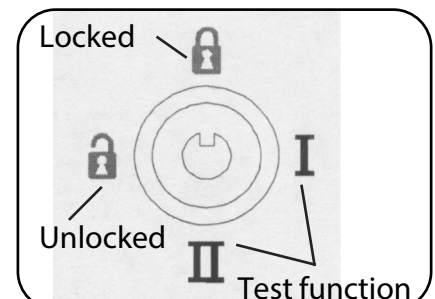


Fig. 8.6.03 – Rotary switch positions

## 8.7 Emergency lowering

### Lowering using the battery (electric)

In the event of a power failure, you can lower the adjustment drives to their lowest position once. This is made possible using the 9-V block battery in the controller. However, the energy is only sufficient to lower the bed once.



Note that only one function button may ever be used at any one time. Otherwise the electrical system can disconnect due to overload.

For safety reasons, the battery must be replaced after every use or during every service in accordance with the chapter on maintenance.

### Emergency lowering of the back part (manual)

If the back part has to be lowered in less than 30 seconds (e.g. to perform CPR), lower the back part manually.



**Always enlist the help of another person for manual emergency lowering!**

**Uncontrolled falling of the back part can severely injure both user and patient!**

**The emergency lowering must only be performed by trained users.** Practice lowering under normal conditions so that you can lower the back part safely in an emergency.

Performing emergency lowering (requires two users)

1. Relieve the back part of any load before performing emergency lowering. To do so, the first user slightly raises the back part at its tube bracket and holds it firmly in this position. The second user must help the first user if necessary. This will relieve the load on the back part so that it can be disconnected from the drive.
2. The second user then folds down the safety bracket of the tube clip, pulls it out and puts it to one side (Fig. 8.7.01). (The drive is disconnected and swivels downwards so it is out of the way. The back part is now no longer held in place by the drive.)
3. Both users then slowly and carefully lower the back part together.

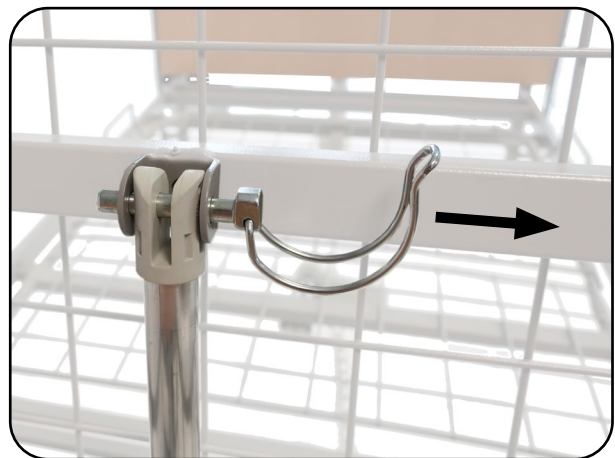


Fig. 8.7.01 – Tube clip for emergency lowering



**When lowering the back part, beware of crushing.**



Once emergency lowering is finished, the back part will remain in the lowered position. Do not restore the homecare bed to its original condition until the patient is no longer in it.

Restoring the homecare bed to its original condition (requires one user)



**Never restore the homecare bed to its original condition while there is a patient in it.**

4. Lift the back part.
5. Swivel the drive up and fully align the hole on the drive with that in the retaining plate. Fasten the drive to the retaining plate by inserting the tube clip. Make sure that the tube clip is engaged from the operating side.
6. Close the safety bracket on the tube clip.
7. Perform an inspection as instructed in the maintenance schedule (see the **Maintenance schedule** in the section on maintenance).



Ensure that the safety bracket on the tube clip is closed at all times.

## 8.8 Mains power cut-off

When the manual control unit is not in operation, the product is disconnected from the mains supply by the maintenance-free mains power cut-off. In this case, there is no mains voltage present in the power cable and transformer. The mains power is not activated until the manual control unit is operated. A capacitor in the mains adapter provides the necessary energy to activate the relay in the mains plug. The capacitor is recharged during every adjustment process and is available for the next operation. The 9 V block battery installed as standard for the emergency lowering buffers the capacitor if necessary if the voltage has been reduced due to self-discharging after weeks of not being operated. If the capacitor is discharged after weeks of not being used and no functional battery is connected, the circuit can be started again by pressing the green button on the mains plug once (Fig. 8.8.01).

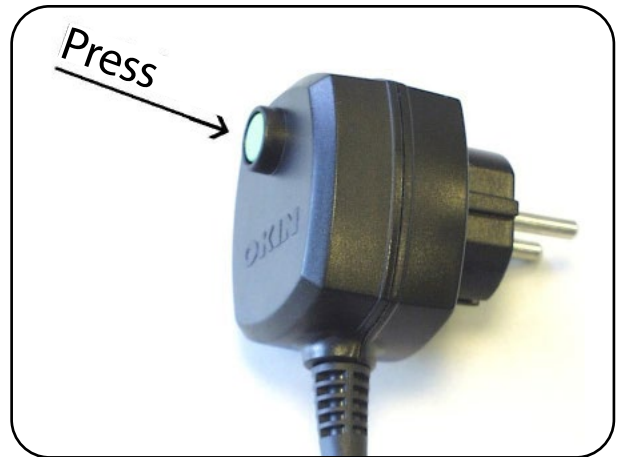


Fig. 8.8.01 – Mains plug

The mains power cut-off provides the following benefits:

- No electrical and electromagnetic alternating fields (“electric smog”) when the drives are shut down
- No idle current consumption when the drives are shut down
- No constant transformer humming
- Compatible with higher level mains power cut-offs



Only plug the mains plug into the mains socket in the suspended position (Fig. 8.8.01). This prevents kinks from developing in the power cable.



**Improper handling can result in damage to the mains plug and in hazards such as electric shock. Never pull on or drive over the mains plug’s power cable.**

**Following transport/storage in cold environments, do not operate the mains plug until it has reached room temperature.**

## 9 Patient transport

The product is suitable for transporting patients.



**Before transport, make sure that the product has been set to its lowest position and that the bed surface is horizontal. The bed surface elements, such as the back part, thigh part and lower leg part, must have been lowered. Pull up the side bars until they audibly engage.**



**Disconnect the product from the mains supply before beginning transport. Use the transport lock during transport in order to avoid driving over the power cable and dropping the mains plug (Fig. 9.02).**



Ensure that none of the patient's limbs protrude from the homecare bed and remove any equipment or objects attached to the homecare bed.

### Procedure:

The transport lock is located in the free uplifter holder (Fig. 9.01). To move the product, wrap the power cable around the bed surface and insert the mains plug in the transport lock (Fig. 9.02).



When inserting the mains plug, ensure that both the plug-in contacts are guided through the openings of the cap and that the mains plug is tight.



Fig. 9.01 – Free uplifter holder with transport lock



Fig. 9.02 – Mains plug in transport lock

## 10 Accessories/combinations



**Only original aks accessory/spare parts may be used as accessories/spare parts, as only these have been tested by aks GmbH and thus guarantee faultless and safe function.** Accessories/spare parts that have not been approved by aks GmbH can cause hazards. Never use drive components produced by other drive manufacturers (see the chapter on Technical data, section **Electrical data**).

**Observe the safe working load** (see chapter on **Technical data**). The permissible patient weight varies depending on what accessories are attached to the bed at the time. The total of the patient weight and the weight of the accessories (e.g. infusion holder, anti-decubitus alternating pressure pump unit) must not exceed the safe working load.

The following table summarises the accessories that have been checked and approved by aks GmbH for safe use of the aks homecare beds described in these instructions for use.

Accessories	REF
Wood side bar height extender (mandatory if the dimension between mattress and side bar top edge < 220 mm)	39273
Assembly tool	39039
Standing aid (light grey)	39899

Further accessories/spare parts available on request.

We reserve the right to make changes and amendments. As a result, the specifications for **REF** may vary. Latest **REF** available on request.

### Combination

The product can be combined with other aks products. These include our anti-decubitus alternating pressure systems and our patient hoists.



**Combinations that have not been approved by aks GmbH can cause hazards.**

**Non-original side bars/height extenders can cause hazards.**



Only use mattresses whose dimensions fit the bed surface of the homecare bed. Also note the maximum permitted mattress heights, which are measured from the bed surface to the top surface of the mattress (see table below):

Bed surface	Max. mattress height without side bar height extender
Metal mesh	14 cm



If the distance between the top surface of the mattress and the top edge of the side bar is less than 220 mm, you must use a side bar height extender or the version with extended height.



Information on suitable aks mattresses available on request.

## 11 Troubleshooting

Not all malfunctions are caused by product faults. The following table provides assistance for troubleshooting. If you are unable to rectify the malfunction using the information in this table, please contact your authorised dealer.



**Repairs to and measurements of the electrical components may only be performed by suitably qualified personnel (see chapter on Maintenance). Other persons (e.g. users) are not under any circumstances permitted to attempt to resolve defects by themselves.**

Malfunctions and their causes		
Malfunction	Possible causes	Remedy
Manual control unit and/or drive system does not function	Lock function activated	Unlock manual control unit
	Mains plug not plugged in and 9 V block battery discharged	Plug in the mains plug and press the green button on the mains plug (mains power cut-off); replace 9 V block battery – contact qualified personnel
	230 V connection (mains socket) has no voltage	Check the mains socket/fuse box and press the green button on the mains plug (mains power cut-off) – contact qualified personnel
	Manual control unit defective	Connect new manual control unit – contact authorised dealer
	Mains power cut-off deactivated and 9 V block battery discharged	Press the green button on the mains plug (mains power cut-off); replace 9 V block battery – contact qualified personnel
No emergency lowering, e.g. in the case of power failure	9 V block battery discharged or no 9 V block battery connected	Replace 9 V block battery – contact qualified personnel
	Manual control unit defective	Connect new manual control unit – contact authorised dealer
Product only moves very slowly	Mains power plug not plugged in or no mains voltage present (e.g. power failure) Product running using 9 V block battery	Plug in mains plug and/or check the reason for the voltage loss and replace the 9 V block battery – contact qualified personnel
Lower leg part cannot be positioned on ratchet adjuster	Lock function activated	Unlock manual control unit



## 12 Cleaning/disinfecting

**Cleaning:** Achieving a state of cleanliness (visible). Removal of contamination to the extent required for the intended purpose of the product.

**Disinfection:** Reducing the number of or destroying microorganisms (not visible). Procedure designed to reduce the number of viable micro-organisms to a pre-defined acceptable level appropriate to the intended purpose of the product.



**When cleaning/disinfecting the product, note that the individual components could be infectious or contaminated. Take suitable precautions for your own safety. Use suitable packaging/labelling to ensure that the product/accessories can be transported without any risks to third parties.**



Note the difference between cleaning/disinfecting for use by “**the same patient**” and cleaning/disinfecting for “**reuse**”. Note that, for reuse in particular, only disinfection methods that are performed according to a validated procedure<sup>1</sup> with the suitable process parameters are permitted. The drives of the stand parts/scissor lift and bed surface elements must be retracted before cleaning and disinfection. This means that the product must be in the bottom position, the bed surface horizontal and the bed surface elements (back, thigh and lower leg parts) lowered.



**For cleaning and disinfection, the product must always be disconnected from the power supply by unplugging the mains plug from the mains socket in order to prevent the risk of electric shock and functional failure (short circuit).** The mains plug must be protected from moisture for the duration of the cleaning/disinfecting process (e.g. using a plastic bag). **Note that protection against spray water (protection type/moisture protection) is only guaranteed when electrical and/or dummy plugs are plugged into all the sockets. The product’s electrical components are protected against spray water to IPX4 as a minimum** (see chapter on technical data, section **Electrical data**). **They must show no external signs of damage.** Note that if there is a difference between the protection types of different components, the lowest permissible protection type must be taken into account. Failure to comply means that safe operation can no longer be guaranteed.

**The electrical components must show no external signs of damage. In case of damage, water and cleaning agents may get into the electrical components. This can cause malfunctions and damage to the electrical components. Do not use the components if they become damaged. Mark the product clearly as “out of order” and inform your authorised dealer immediately. Before putting the product back into use, make sure that there is no residual moisture on the electrical contacts. This can be done by wiping or blowing the contacts dry. If water or cleaning agent has got into the components, do not use them. Mark the product clearly as “out of order” and inform your authorised dealer immediately.**



**Never clean the product, particularly the electrical system, with a high pressure cleaner, water hose or in an automatic bed washing system because the surfaces and seals can be damaged and water can penetrate.**

Failure to observe the safety instructions can result in significant damage to the product, and may have further aftereffects.

<sup>1</sup> E.g. in accordance with the requirements of the Robert Koch Institute (RKI) or another procedure that has been validated by the operator/treatment personnel.

## 12.1 General cleaning and disinfecting instructions

The product is suitable for reuse (see the chapter on **Reuse**). The product is manufactured subject to the highest quality standards. The following manufacturer information on cleaning/disinfecting must always be observed to ensure that the characteristics stated by the manufacturer do not change. This is the only way to guarantee that the product is safe and effective for its intended purpose.

Both domestic and professional cleaning agents and disinfectants can be used to clean and disinfect the product. The following points must be observed:

### Never use

- Abrasive agents or cleaning materials containing ammonium chloride
- Basic/alkaline cleaning agents
- Aggressive cleaning materials, e.g. solvents and hard brushes etc.
- Oil-based furniture polishes for the electrical components

### If possible, use

- Environmentally and dermatologically tested cleaning agents
- Alcohol-free and chlorine-free disinfectants and methods for wipe disinfection from the Robert Koch Institute (RKI) list or the disinfectants list of the Verbund für Angewandte Hygiene e. V. (VAH).

Observe the instructions and safety precautions from the manufacturers of the cleaning and disinfectant materials.



Clean and disinfect the product at regular intervals and whenever there is evident soiling, and keep a proper log of the cleaning/disinfection.

Note that the surfaces of the product must be undamaged when cleaning/disinfecting them, otherwise moisture can get into the product. In case of damage (e.g. scratches/dents that go all the way through the varnish), contact your authorised dealer immediately.



In addition to regular maintenance, regular cleaning helps to identify loose and/or worn parts. This ensures trouble-free operation and extends the product's service life.

Disinfection of the castors is only required if they are visibly contaminated with infectious/potentially infectious material.

Wear gloves during cleaning/disinfection to prevent the cleaning agents/disinfectants from coming into direct contact with your skin.

Keep the surface disinfectants you use in sealed containers and note that these will need replacing at regular intervals in accordance with the manufacturer's specifications. We recommend using re-sealable pump dispensers to apply cleaning agents/disinfectants to cleaning cloths.

Make sure the room is ventilated sufficiently, or air it out thoroughly after disinfecting the surfaces of the product.



## 12.2 Cleaning by the user/operator

The product can be cleaned by hand with a damp cloth and a mild, alcohol-free cleaning agent.

## 12.3 Disinfection by the user/operator

Please note: it is important to clean the product thoroughly prior to disinfection! To disinfect the product by hand, use a wipe disinfection method. For regular disinfection by the user, domestic disinfectants can be used. Validated disinfectants<sup>2</sup> must always be used when carrying out treatment for reuse.

If you have further questions regarding disinfection, please contact your authorised dealer.

## 12.4 Approved disinfectants



When using disinfectants and disinfection methods, always observe the corresponding information from the manufacturer, particularly the specifications regarding concentration (dosage) and exposure time. Always use cold water (max. 30°C) when diluting disinfectants.

The following disinfectants and disinfection methods have been tested and approved by aks GmbH.

### Wipe disinfection

Manufacturer of disinfectant	Designation / active ingredient	Effectiveness* (degree of disinfection)
Ecolab	Incidin™ Rapid <sup>3</sup>	A

\* A: Suitable for killing vegetative bacteria, including mycobacteria and fungi including fungal spores

2 e.g. from the Robert-Koch Institut (RKI) list or the disinfectants list of the Verbund für Angewandte Hygiene e.V.(VAH) or another disinfectant/method that has been validated by the operator/treatment personnel.

3 According to the Verbund für Angewandte Hygiene e.V. (VAH) Active ingredient basis: Aldehyde(s), quaternary compound(s)

## 13 Storage

The storage location should be as cool and dry as possible and not exceed normal room temperature. The climatic conditions are described in the chapter on **Technical data** and must be complied with.



Ensure damage and continual strain are ruled out during the storage period.

Do not place anything on the product that could damage it (e.g. pointed objects with sharp edges).



For long-term storage, the product should be stored in a clean and dry state. Use the original packaging for storage to protect the product against dust and/or cover the product with foil or a sheet.

In the event of longer storage or non-use, remove the 9 V block batteries as a precaution, as described in the chapter on Maintenance, section **Removing/replacing the batteries**.

Keep the product away from direct sunlight, fire and heat sources (e.g. heating, stoves etc.).

### 13.1 Shutdown

If the product is no longer to be used and is to be removed from service, proceed as follows:

1. Brake the castors on the homecare bed (see chapter on Operation, section **Castors**).
2. Remove the mattress and accessories, such as the uplifter (see chapter on assembly, Section **Assembling the uplifter and grab handle**).
3. Move the homecare bed to the lowest horizontal position (see the chapter on maintenance, section **Manual control unit**).
4. Disconnect the product from the mains supply; to do this, unplug the mains plug from the mains socket.
5. Remove the strain relief (power cable) (see the chapter on assembly, section **Assembling the controller** – Fig. 6.2.02).
6. Remove the plug for the thigh drive (see the chapter on assembly, section **Assembling the controller** – Fig. 6.2.03).
7. Remove the plug for the scissor lift (see the chapter on assembly, section **Assembling the controller** – Fig. 6.2.03).

To save space during storage, dismantle the homecare bed by reversing the steps described in the chapter on Assembly.

## 14 Reuse

The products described in the instructions for use are suitable for reuse. Before reusing the product in question (e.g. in the event of a change of patient), make sure that it has been cleaned and disinfected as described in the chapter on **Cleaning/disinfecting** and serviced as described in the chapter on **Maintenance**, and that any defects or damage found has been repaired by the appropriate qualified personnel and/or the components in question replaced.



Observe the safety instructions (see chapter on **Safety instructions**).

## 15 Service life

If the product is used as intended, cleaned and disinfected as described in the chapter on **Cleaning/disinfecting**, and maintenance work is carried out at regular intervals as defined in the maintenance schedule (see chapter on **Maintenance**), a service life/useful life of up to **eight years** is possible.



**Do not use a damaged or severely worn product.** Failure to observe this requirement will increase the risks associated with using the product.



Observe the permissible safe working load (see chapter on **Technical data**). Exceeding the permissible safe working load not only reduces the service life/useful life of the product, it also increases the risk that is always present when the product is used.

Observe the permissible on-time for the drives. Exceeding the permissible on-time (see chapter on Technical data, section **Electrical data**) also reduces the service life/useful life of the product.



The product's service life/useful life is of course dependent on how it is used (usage conditions/frequency of use). Frequent adjustment, transportation, set-up, cleaning and disinfection reduce the service life/useful life, as do improper handling, improper storage and irregular maintenance.

If the products are treated properly and handled carefully, cleaned/disinfected as described in the chapter on **Cleaning/disinfecting**, and maintained regularly in accordance with the maintenance schedule (see chapter on **Maintenance**), they can also be used for longer.

The fact that aks GmbH specifies an expected service life/useful life for the products does not represent an additional guarantee.

Note that additional specifications regarding service life/useful life may apply to individual components (e.g. the grab handle, see the **Uplifter** section in the chapter on Operation).

## 16 Disposal

The product described in the instructions for use comprises metal, wood and plastic parts along with electrical components. These must be disposed of properly, separately and in accordance with the statutory requirements.

Sort the packaging materials according to the parts that are recyclable, and recycle these in accordance with the applicable environmental regulations. Properly dispose of the parts that are not recyclable in your country.



**When disposing of the product, note that the individual components could be infectious or contaminated. Take suitable precautions for your own safety. Use suitable packaging/labelling to ensure that the product/accessories can be disposed of without any risk to third parties.**

Contact your local disposal company. For disposal in countries other than Germany, observe the respective applicable national laws, regulations and provisions.

The products are compliant with Regulation (EU) 2020/171, known as the REACH Regulation of the European Parliament and of the Council dated 6 February 2020 concerning the Registration, Evaluation, Authorisation and Restriction of Chemicals.

This product is classed as an item of electrical and electronic equipment intended for professional use (b2b) in accordance with the WEEE Directive 2012/19/EU (Waste Electrical and Electronic Equipment). The electrical components must be treated as waste electrical equipment in accordance with the WEEE Directive and disposed of properly. This is indicated by the symbol in Fig. 16.01.

The products comply with EU Directive 2011/65/EU, known as RoHS II of the European Parliament and Council dated 8 June 2011 for the Restriction of the use of Certain Hazardous Substances in electrical and electronic equipment.

In the case of electrical equipment brought into circulation after 13 August 2005, the owner is legally obligated not to hand over electrical components to municipal collecting points but to send them directly to the manufacturer for disposal. The general terms and conditions of aks GmbH apply to these returns.



Fig. 16.01 – WEEE marking

**Notice pursuant to the German Batteries Act (BattG)**

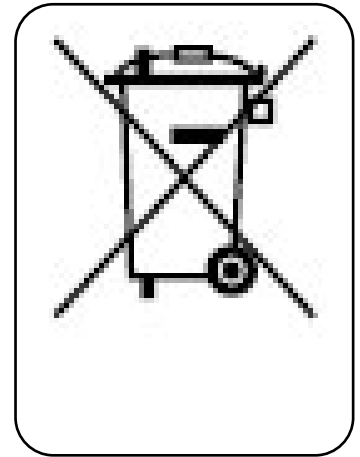
The batteries contained in this product are subject to the Batteries Act (BattG). Discharged batteries must not be disposed of in domestic waste. This is indicated by the symbol in Fig. 16.02.

The end user is legally obligated to return discharged batteries. They can be submitted free-of-charge to a municipal collection point or returned to aks GmbH for proper disposal. The general terms and conditions of aks GmbH apply to these returns.

Batteries can contain hazardous substances that may harm the environment or human health if they are stored or disposed of improperly. Batteries contain valuable resources which can be reused through separate collection.



**Make sure that the poles of batteries are insulated when disposing of them or sending them for disposal.**



**Fig. 16.02 – BattG marking**

## 17 Warranty

The products described in these instructions for use are distinguished by their long service life and high reliability. Should a fault occur and the product cease to operate correctly, check the malfunction using the table in the chapter on **Troubleshooting**. If the fault cannot be cleared in this way, contact your authorised dealer, who will provide a remedy as quickly as possible and procure the required spare parts.

We guarantee the faultless condition of our products in accordance with our sales and delivery conditions. We provide a manufacturer's warranty for material defects in wooden components for **12 months** from the date of purchase, and a manufacturer's warranty for all other components for **36 months** from the date of purchase (soiling and normal wear are not covered by the warranty).



Non-observance of the instructions for use, improper use, improperly carried out maintenance work, and technical modifications and additions (e.g. attachments) without the permission of aks GmbH render the warranty and general product liability void.

Before using the product on parquet/natural wood floors, check whether the floor sealant is suitable for preventing the castors from causing damage (e.g. discolouration). Aks GmbH accepts no liability for damage arising from everyday use on floors (see chapter on operation, section **Castors**).

We reserve the right to make technical changes for the purpose of improvement. For the product designation and information for clear identification (e.g. **SN**, **LOT**), refer to the rating plate (see chapter on **Product labelling**).

## 18 Declaration of conformity

The products described in these instructions for use comply with all the applicable requirements of Regulation (EU) 2017/745 on Medical Devices (MDR). During the development, the applicable parts of the following standards were taken into account:

- EN 60601-1 Medical electrical equipment – Part 1:  
General requirements for basic safety and essential performance
- EN 60601-1-2 Medical electrical equipment – Part 1-2:  
General requirements for basic safety and essential performance –  
Collateral standard:  
Electromagnetic disturbances – Requirements and tests
- EN 60601-2-52 Medical electrical equipment – Part 2-52:  
Particular requirements for basic safety and essential performance of  
medical beds

The full Declaration of Conformity is available on request.

## 19 Maintenance

### 19.1 General maintenance instructions

The service life of the products (incl. accessories) described in these instructions for use is of course dependent on the type of use.



In order to ensure safe operation, the product in question must be visually inspected and functionally checked at regular intervals by appropriate qualified personnel, at least once a year, every time the product is reused and after every repair, followed by an electrical check, in accordance with the maintenance schedule. Shorter inspection cycles may be necessary if the product is used more frequently than normal.

If the product is not regularly and properly serviced, safe use is no longer guaranteed. Wear, damage or also loosening of connecting elements can thus not be detected.



If any checks indicate defects/damage, immediately disconnect the product from the mains supply and do not operate it again. Mark the product clearly as "out of order" and inform your authorised dealer immediately.



**Unplug the product from the mains supply before the visual inspection to prevent danger, e.g. from damaged power cable insulation. If no damage is detected during the visual inspection, reconnect the product to the mains supply to perform a function test.**

**Defective/damaged electrical components must be replaced by suitable qualified personnel. Electrical components must not be opened and must be replaced as complete units.** Exception: Replacement of the batteries (controller) by suitable trained and qualified personnel.

**Removed, defective/damaged electrical components may only be checked and evaluated by a qualified electrician or aks GmbH.**



Do not carry out any repairs on the product that would alter the product characteristics. If this instruction is not observed, safe care can no longer be guaranteed and the risks associated with using the product will increase. In addition, any warranty claim and product liability are excluded.

Maintenance may only be carried out on empty homecare beds. Remove the mattress and accessories, such as the uplifter (see chapter on assembly, Section **Assembling the uplifter and grab handle**).



Only original aks spare parts and aks accessory parts that are approved for this product may be used (see chapter on **Accessories/combinations**). Otherwise, any warranty claims and product liability are excluded. You must not make any technical modifications and additions without permission from aks GmbH.



In Germany, the EU Medical Devices Adaptation Act (MPEUAnpG) applies, including the Medical Devices Implementation Act (MPDG) and the Medical Devices Operator Ordinance (MPBetreibV). The corresponding national laws, regulations and requirements are applicable in other countries.

The latest versions of EN 62353 and the maintenance schedule must be used as test specifications for the products (incl. accessories) described in these instructions for use, and this must be properly documented.

Perform all tests under normal indoor ambient conditions (humidity and temperature). Perform the tests in the specified order (visual inspection first, then functional check). Perform all the tests on the same product and document your results. The following information must be provided as a bare minimum:

- Name and address of testing company
- Name of tester
- Test date
- Information on the product, incl.: Type, size, date of manufacture/production, serial number, catalogue number where applicable
- Name and address of the manufacturer
- Test results
- Indication of next test date



**Also read and observe the instructions for use for the accessories.**

## 19.2 Removing/replacing the batteries

If the product has been lowered by means of emergency lowering or using the battery instead of mains voltage, the 9 V block battery must be replaced.



The original 9 V block battery must only be replaced with an equivalent alkaline manganese battery TYPE 6LR61.



Unusable rechargeable and non-rechargeable batteries must not be disposed of in domestic waste. These must be disposed of in accordance with the regulations for the return and disposal of used rechargeable and non-rechargeable batteries (see the chapter on **Disposal**).

The sealed battery compartment must be opened to access the 9 V block battery.

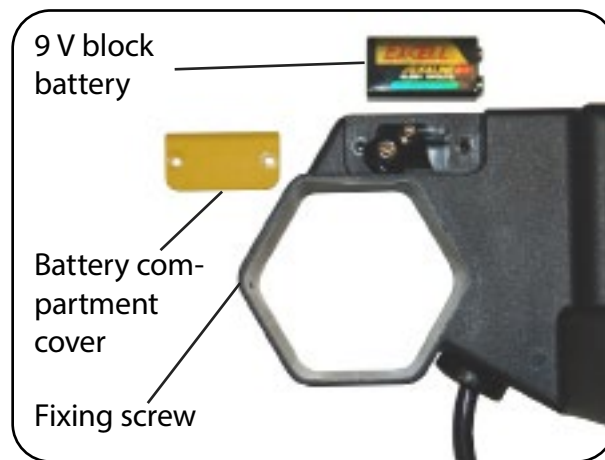


Fig. 19.2.01 – Controller battery compartment

### Removing the battery:

1. Raise the back part and lower the side bar (if present).



Now remove the mains plug from the mains socket.

2. Undo the fixing screw using a Phillips screwdriver and remove the controller from the back part drive. Pay attention to the routing of the power cable while doing so.
3. Using a Philips screwdriver, undo the fastening screws on the battery compartment cover and remove the cover.
4. Remove the battery from the battery compartment and disconnect the contact connector from the battery.

### Inserting the battery:

5. Press the contact connector firmly onto the new battery and insert the battery into the battery compartment.
6. Screw the cover back onto the battery compartment using the fastening screws. Ensure that you do not damage the seal and do not overtighten the fastening screws.
7. Push the controller back onto the back part drive and secure it against slipping away using the fixing screw. Pay attention to the routing of the power cable while doing so.
8. Finally, check the power cable routing, the plug connections and the firm seating of the controller.

### 19.3 Maintenance schedule: Inspection by the operator

Perform maintenance of the product (incl. accessories) at least once a year, before every reuse, and after every repair.



Article 7 of the MPBetreibV specifies the following:  
*“Maintenance measures refer to inspections and **maintenance tasks** that are necessary in order to continuously ensure safe and proper operation of medical devices. The maintenance measures shall be performed taking the **manufacturer’s instructions** into consideration (...).”*

If an error rate of less than 2% is identified and properly documented during inspections **of the electrical components**, the inspection interval for the electrical components can be extended accordingly (max. two years<sup>1</sup>); see also the latest version of DGUV Specification 3; § 5; Table 1B. Regardless of the error rate, a full inspection as described in the maintenance schedule must be performed by suitable qualified personnel before each reuse and after each repair.

The following maintenance schedule provides help for this inspection:

Application area	
<input type="checkbox"/> Private household	<input type="checkbox"/> In-patient facility <input type="checkbox"/> _____
Client: _____	Date of first use (MM/YYYY) ____/____
Last inspected on: _____	by: _____
Inspection prior to initial commissioning conducted on: _____	by: _____
Data for the aks homecare bed	
Date of manufacture (MM/JJJJ) ____/____	<b>SN</b> _____
Inventory number: _____	

UDI-DI for the aks homecare bed					
European, contoured					
Dimensions [cm]	UDI-DI				
	aks-SB L		aks-SB XL		aks-SB XXL
90 x 190	04251818702631	<input type="checkbox"/>	<del>04251818702761</del>	<input type="checkbox"/>	<del>04251818702853</del>
100 x 200	04251818702648	<input type="checkbox"/>	04251818702761	<input type="checkbox"/>	<del>04251818702853</del>
100 x 220	04251818702655	<input type="checkbox"/>	04251818702778	<input type="checkbox"/>	<del>04251818702853</del>
120 x 200	04251818702662	<input type="checkbox"/>	04251818702785	<input type="checkbox"/>	04251818702853 <input type="checkbox"/>
120 x 220	04251818702679	<input type="checkbox"/>	04251818702792	<input type="checkbox"/>	04251818702860 <input type="checkbox"/>
120 x 240	<del>04251818702693</del>	<input type="checkbox"/>	04251818702808	<input type="checkbox"/>	<del>04251818702877</del>
140 x 200	04251818702693	<input type="checkbox"/>	<del>04251818702808</del>	<input type="checkbox"/>	<del>04251818702877</del>
140 x 220	<del>04251818702693</del>	<input type="checkbox"/>	<del>04251818702808</del>	<input type="checkbox"/>	04251818702877 <input type="checkbox"/>
140 x 240	<del>04251818702693</del>	<input type="checkbox"/>	<del>04251818702808</del>	<input type="checkbox"/>	04251818702884 <input type="checkbox"/>

(\*)

OK	in order	The condition or the function complies with the requirements
NOK	not in order	The condition or the function does not comply with the requirements. The defect has to be rectified by a repair or replacement
n/a	not applicable	Property/component not present

1 Article 11 of the MPBetreibV specifies the following for technical safety inspections for the medical devices specified in Annex 1 of the MPBetreibV:  
*“The owner shall schedule inspection intervals accordingly to ensure that the defects that are to be expected on the basis of past experience can be identified in good time.”*

Technical safety inspections do not apply to the products described in these instructions for use. The wording specifies the owner’s responsibility.

UDI-DI for the aks homecare bed				
Country variants				
Model	Dimensions [cm]	Country variant	UDI-DI	
aks-SB L	100 x 200	UK	04251818702747	<input type="checkbox"/>
	120 x 200	UK	04251818702709	<input type="checkbox"/>
		European, flat	04251818702686	<input type="checkbox"/>
	120 x 220	UK	04251818702716	<input type="checkbox"/>
		European, flat	04251818702730	<input type="checkbox"/>
	140 x 200	UK	04251818702754	<input type="checkbox"/>
European, flat		04251818702723	<input type="checkbox"/>	
aks-SB XL	120 x 200	UK	04251818702839	<input type="checkbox"/>
		European, flat	04251818702815	<input type="checkbox"/>
	120 x 220	UK	04251818702822	<input type="checkbox"/>
		European, flat	04251818702846	<input type="checkbox"/>

<b>Maintenance schedule for aks homecare beds</b>							
Item	Inspection points*	Check point for:				OK	NOK
		SBL SB XL SB XXL	B4 L B4 XL B4 XXL	n/a			
<b>1</b>	<b>Check of the basic requirements</b>						
1.1	Appropriate and safe use (no collision points or objects above or under the bed)	X	X				
1.2	Permitted accessories or equipment combination	X	X				
1.3	No additional power sockets, such as multiple socket used for connection	X	X				
1.4	Rating plate and date of manufacture sticker present and legible	X	X				
1.5	Operating manual available, legible and accessible to user	X	X				
<b>2</b>	<b>Visual inspection of the mechanical parts</b> You will need a tape measure to check the spacing/dimensions. The product must be disconnected from the mains supply.						
2.1	No unauthorised interventions, modifications or improper handling	X	X				
2.2	No soiling (particularly on the lift tubes of the drives)	X	X				
2.3	No surface damage or corrosion	X	X				
2.4	No deformation or sheared weld seams	X	X				
2.5	No mechanical wear	X	X				
2.6	Connection elements: Screws in place and tightened	X	X				
2.7	Connection elements: Pins present and secured	X	X				
2.8	Connection elements: Locking plates present and secured	X	X				
2.9	Connection elements: Tube clips present and secured	X	X				
2.10	Castors: undamaged and fastened	X	-				
2.11	Firm footing: all four feet are present and correctly installed	-	X				
2.12	Firm footing: all four feet are in firm contact with the floor	-	X				
2.13	End panels: undamaged and fastened	X	-				
2.14	Release buttons undamaged and easy to press	X	-				

Maintenance schedule continues on next page.

Item	Inspection points*	Check point for:				n/a	OK	NOK
		SB L SB XL SB XXL	B4 L B4 XL B4 XXL					
		(X) = include accessories, if present						
2.15	Side bar stopper present and fastened	X	-					
2.16	End panels: Inside protective caps present	X	-					
2.17	Bed frame fixture used, safety distance of 25 mm between outer edge of bed surface and bed frame maintained all round	-	X					
2.18	Side bars: undamaged and fastened	X	(X)					
2.19	Side bars: Distance between slats less than 120 mm	X	(X)					
2.20	Side bars: Distance between mattress's top edge and top edge of side bars is at least 220 mm	X	(X)					
2.21	Side bars: Distance between side bars and head board less than 60 mm	-	(X)					
2.22	Uplifter and uplifter mounting: undamaged, free of wear, rating plate and sticker with date of manufacture present on uplifter	X	(X)					
2.23	Grab handle with strap: undamaged, no wear, particularly no deformation or cracks on grab handle	X	(X)					
2.24	Infusion holder: rating plate present, date of manufacture present, protective caps present, undamaged, not bent, weld seams free of cracks; check stability by hand	(X)	(X)					
2.25	Transport lock for mains plug present, not damaged	X	X					
2.26	Emergency lowering freely accessible, tube clip engaged from operating side	X	X					
2.27	Emergency lowering: tube clip is engaged (safety bracket folded down)	X	X					
2.28	Caps and dummy plugs present and undamaged	X	X					

Item	Inspection points*	Check point for:				n/a	OK	NOK
		SBL SB XL SB XXL	B4 L B4 XL B4 XXL					
<b>3</b>	<b>Visual inspection of the electrical parts</b> The product must be disconnected from the mains supply.							
3.1	Product-specific drive components present, no systems comprising a mixture of different brands (see <b>Technical Data</b> chapter)	X	X					
3.2	Power cable and mains plug undamaged	X	X					
3.3	Strain relief/kink protection installed and firmly attached (see also chapter on <b>Assembly</b> )	X	X					
3.4	Power cable: routed correctly, undamaged, not crushed/shorn, no risk of catching	X	X					
3.5	Drives and controller are undamaged and clean, rating plate is present and legible	X	X					
3.6	All enclosures of the electrical system OK: O-rings; seals; no cracks on cases, fork heads and lift tubes	X	X					
3.7	Drives: attached correctly, pins and locking plate in place, tube clip for attaching the back part drive present	X	X					
3.8	Controller firmly attached to back part drive and secured with the fixing screw / controller is firmly screwed onto the holder (for SB XXL and B4 XXL)	X	X					
3.9	Replace 9 V block batteries (alkali manganese battery type 6LR61) (see chapter on Maintenance, section <b>Removing/replacing the batteries</b> )	X	X					
3.10	All plug connectors plugged into the correct sockets on the controller (see chapter on Assembly, section <b>Assembling the controller</b> ). All sockets on the controller closed with connector with O-ring or with blanking plugs with O-ring. Strain relief Z used for power supply cable to the manual control unit (socket H) (not available for SB XXL and B4 XXL).	X	X					
3.11	Manual control unit: no damage (e.g. fractures)	X	X					
3.12	Manual control unit: no soiling or other abnormalities	X	X					

Maintenance schedule continues on next page.



Item	Inspection points*	Check point for:				OK	NOK
		SB L SB XL SB XXL	B4 L B4 XL B4 XXL	n/a			
(X) = include accessories, if present							
<b>4</b>	<b>Electrical inspection according to DIN EN 62353</b> The product must have passed the visual inspection! The product must be connected to the mains supply.						
4.1	Device leakage current – alternative measurement method: max. 500 µA Note: Insulation resistance measurement must not be performed. Voltages of more than 1 kV can result in damage.	X	X				
<b>5</b>	<b>Function test of manual control unit</b> The product must have passed the visual inspection! The product must be connected to the mains supply.						
5.1	All buttons of the manual control unit are functional during performance of the adjustment functions	X	X				
5.2	To check the lock function (see the chapter on Operation, section <b>Lock function</b> ) (not available for SB XXL and B4 XXL): - When in the “locked” position, the buttons must not activate any functions when pressed - When in the “unlocked” position, all functions must operate normally when the buttons are pressed	X	X				
5.3	To check the power supply cable to the manual control unit (see the chapter on Operation, section <b>Lock function</b> ) (not available for SB XXL and B4 XXL): - When the rotary switch is in position I or II, the buttons must not activate any functions when pressed.	X	X				
<b>6</b>	<b>Function test</b> The product must have passed the visual inspection! The product must be connected to the mains supply.						
6.1	Side bars: Correctly assembled and engaged	X	(X)				
6.2	Check the side bar fixture	-	(X)				
6.3	Castors: all four arresters function correctly: braking function, locking	X	-				
6.4	Castors: easy running, can be swivelled, no unusual noises	X	-				
6.5	Drives (traverse complete adjustment ranges using the manual control unit, easy running, speed, switch off in both directions by limit switch, no unusual operating temperature, no unusual noises)	X	X				
6.6	Manual emergency lowering: the tube clip on the back part drive is closed, the safety bracket possesses sufficient spring tension	X	X				
6.7	Electrical emergency lowering: Disconnect the mains plug from the mains supply. A downward movement must occur by pressing and holding the back part lowering button on the manual control unit for a short time (max. 2 seconds) (if necessary, replace 9 V block batteries again as described in the section on <b>Removing/replacing the batteries</b> in the chapter on Maintenance).	X	X				
6.8	Mains power cut-off audible clicking for every operation of the manual control unit	X	X				

Maintenance schedule continues on next page.

Overall assessment of the aks homecare bed			
aks homecare bed and accessories are in order: <input type="checkbox"/> YES <input type="checkbox"/> NO			
Remark:			
Test date	Company	Inspector	Signature

Data for the aks homecare bed and the aks accessories				
Product	Model	SN	Date of manufacture	Next maintenance/ inspection
Homecare bed				
Uplifter	<del> </del>	<del> </del>	<del> </del>	<del> </del>
Grab handle with strap	<del> </del>	<del> </del>	<del> </del>	<del> </del>
Infusion holder	<del> </del>	<del> </del>	<del> </del>	<del> </del>
Side bar height extender	<del> </del>	<del> </del>	<del> </del>	<del> </del>
Bed extension	<del> </del>	<del> </del>	<del> </del>	<del> </del>
Standing aid	<del> </del>	<del> </del>	<del> </del>	<del> </del>

### 19.4 Maintenance schedule: Inspection by the user

In addition to the periodic checking by suitable qualified personnel, the user must check that the product (incl. accessories) is in a safe state before each use. Do not use the product/accessories if you are concerned about the safety of doing so. Contact your authorised dealer immediately.



Regularly and at short intervals, check the product (incl. accessories) for obvious damage or wear on its mechanical and electrical components (e.g. monthly and after any mechanical strains that occur).

Regularly, after every change of location, and after any mechanical strains that occur (e.g. if someone drives over the power cable), check the power cable that runs from the mains plug to the homecare bed and the power cable that runs from the manual control unit to the controller.



**Do not use a damaged or severely worn product.** Failure to observe this requirement will increase the risks associated with using the product.

The following maintenance schedule provides help for this inspection:

Inspection of the aks homecare bed/lifting homecare bed frame – check points
Product and accessories show no obvious signs of damage or wear (e.g. corrosion, deformation, sheared weld seams)
Appropriate and safe use (no collision points or objects above or under the bed)
No additional power sockets, such as multiple socket used for connection
Emergency lowering freely accessible, tube clip engaged from operating side
Emergency lowering: tube clip is engaged (safety bracket folded down)
Power cable and mains plug undamaged
Power supply cable: routed correctly, undamaged, not crushed/shorn, no risk of catching
No unusual noises
Manual control unit: no damage (e.g. fractures), no soiling or other abnormalities



If any checks indicate defects/damage (e.g. damaged insulation), immediately disconnect the product from the mains supply and do not operate it again. Mark the product clearly as “out of order” and inform your authorised dealer immediately.

20 Product labelling

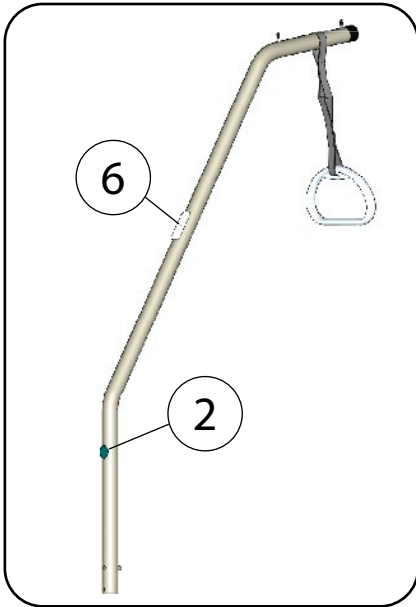


Fig. 20.01 – Uplifter  
up to 100 cm bed surface width

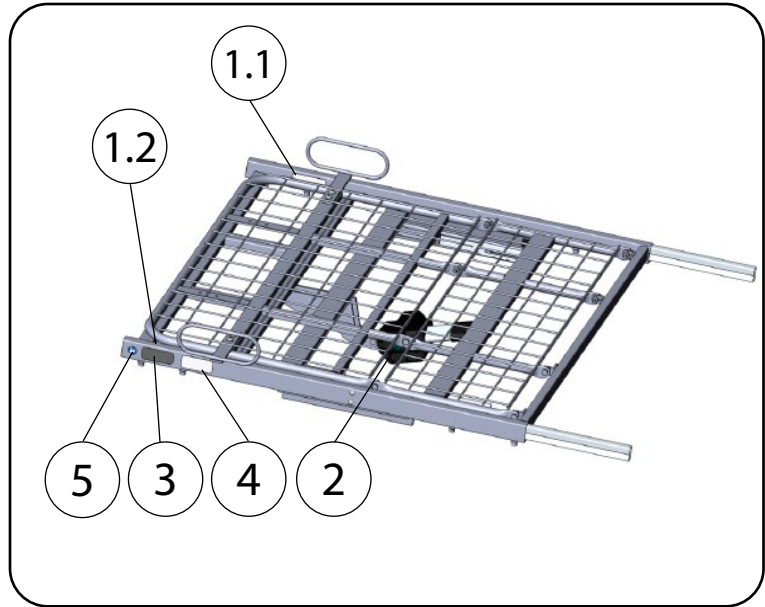


Fig. 20.02 – Foot support

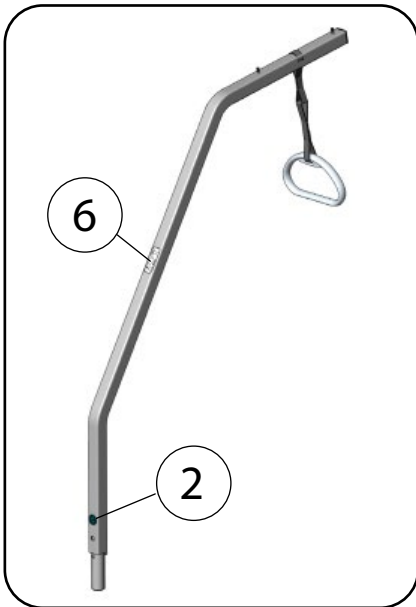


Fig. 20.03 – Uplifter  
from 120 cm bed surface width

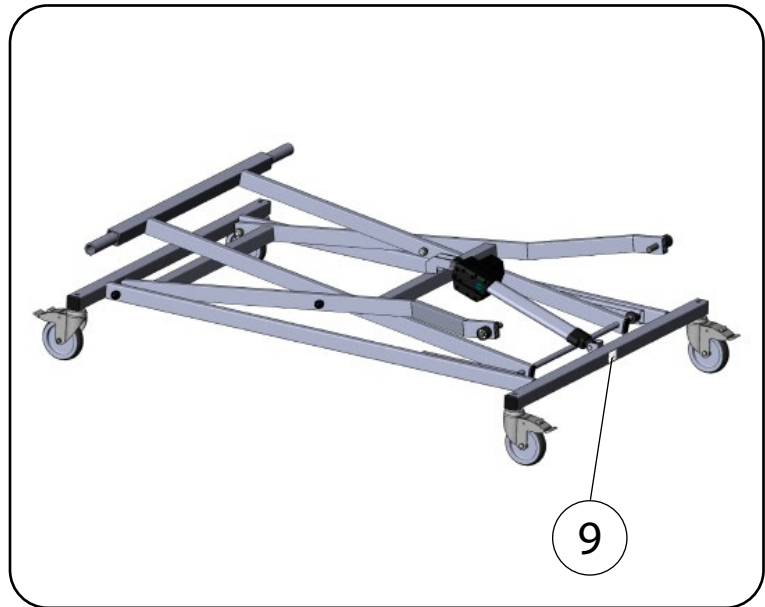







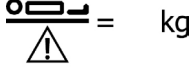
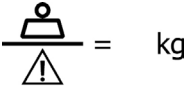






Fig. 20.04 – Scissor lift

Item	Product labelling													
1.1	<p><b>MD class I</b> </p> <p>Eingang: XXX V-XXX V ~ XXX Hz XX A Ausgang SMPS: XX V== XX A Einschaltzyklus: Max. ED X min, Min. AD XX min</p> <p><b>aks</b> aks Aktuelle Krankenpflege Systeme GmbH Antwerpener Straße 6 D-53842 Troisdorf www.aks.de</p>	<p><b>Rating plate (technical)</b></p> <p>Position: - Foot support (inside)</p> <p>See also chapter on <b>Technical data</b></p>												
1.2	<p><b>Modell: aks-XXX</b></p> <p><b>REF</b> XXXXXXXX</p> <p><b>SIZE</b> B x L cm</p> <p><b>SN</b> XXXXXXXXXXXX</p> <p><b>UDI</b> (01)0425181870XXXX (21)XXXXXXXXXXXX</p> <table border="1"> <tr><td>1</td><td>2</td><td>3</td></tr> <tr><td>4</td><td>5</td><td>6</td></tr> <tr><td>7</td><td>8</td><td>9</td></tr> <tr><td>10</td><td>11</td><td>12</td></tr> </table>	1	2	3	4	5	6	7	8	9	10	11	12	<p><b>Rating plate (organisational)</b></p> <p>Position: - Foot support (inside)</p> <p>See also chapter on <b>Technical data</b></p>
1	2	3												
4	5	6												
7	8	9												
10	11	12												
2		<p><b>Date of manufacture</b></p> <p>Position: - Head support - Stand parts/scissor lift - All drives - Uplifter - Accessories, e.g. infusion holder, bed extension etc.</p>												
3		<p><b>Warning sign</b></p> <p>- Removable side bars - Replaceable mattress</p> <p>Position: - Foot support (outside)</p>												
4		<p><b>Warning sign</b></p> <p>Min. patient body weight = 40 kg Min. patient height = 146 cm Min. patient BMI = 17</p> <p>Position: - Foot support (outside)</p>												
5		<p><b>Warning sign</b></p> <p>- Follow instructions for use</p> <p>Position: - Foot support (outside)</p>												
6	<p><b>Aufrichter</b> <b>aks</b> uplifter </p> <p><b>max. 80 kg</b></p> <p>aks Aktuelle Krankenpflege Systeme GmbH Antwerpener Straße 6 D-53842 Troisdorf www.aks.de</p>	<p><b>Uplifter rating plate</b></p> <p>Position: - Uplifter</p>												
7	<p><b>Infusionshalter</b> infusion holder</p> <p><b>max. 2 kg</b> </p> <p><b>aks</b></p> <p>aks Aktuelle Krankenpflege Systeme GmbH Antwerpener Straße 6 D-53842 Troisdorf www.aks.de</p>	<p><b>Rating plate on optional infusion holder</b></p> <p>Position: - Infusion holder</p>												
8		<p><b>Warning sign</b></p> <p>- Individual part weighs more than 20 kg</p>												

z4200272\_GA\_Bett\_SB-L\_220622\_Rev01\_GB

Explanation of the symbols	
	CE-Marking – this product satisfies the applicable requirements of the Regulation (EU) 2017/745 on Medical Devices (MDR) and other legal requirements of the European Union regarding affixing the relevant marking.
	Dimensions of the product
	Medical device as per Regulation (EU) 2017/745 on medical devices
<b>class I</b>	Class I according to Regulation (EU) 2017/745 on medical devices (MDR), Annex VIII
	Unique Device Identifier (UDI) - means a series of numeric or alphanumeric characters that allows unambiguous identification of specific devices on the market
	Follow instructions for use (ISO 7010-M002)
	The batteries contained in the product are subject to the German Batteries Act (BattG) and must not be disposed of with household waste.
	WEEE marking (the device must not be disposed of with domestic waste)
	Patient weight
	Safe working load
	Individual part weighs more than 20 kg (ISO 7000-1321)
	Safety transformer fail-safe (IEC/DIN EN 61558)
	Loudspeaker connector
	Labelling for the application of the EN 60601 series of standards

Explanation of the symbols		EN ISO 15223-1
	Observe instructions for use	
	Attention	
	Manufacturer	
	Date of manufacture	
	Article number	
	Serial number	
	Air pressure, limit	
	Humidity, limit	
	Temperature, limit	
	Keep dry/store in a dry place	
	Protect against heat/sunlight	
	Fragile, handle with care	
Explanation of the symbols		IEC 60417
	For indoor use only	
	Protection class II against electric shock	
	Application part type B	
	Top	
	Switched mode power supply	



Protection type of the enclosure acc. to EN 60529	
IPXX	First digit: Level of protection against contact and foreign objects Second digit: Level of protection against water
IPX4	4 - Protection against splash water on all sides
IPX5	5 - Protection against water jets (nozzle) from any angle
IPX6	6 - Protection against high-pressure water jets (nozzle) from any angle

## 21 Technical data

General information on the product						
Classification	active class I medical device according to Regulation (EU) 2017/745, Annex VIII					
Basic UDI DI	425181871776011HP					
Safe working load (incl. patient, mattress, accessories) [kg]	190					
Max. patient weight [kg]	150					
Operating force for the manual control unit [N]	< 5					
Climate conditions	Ambient temperature [°C]	Use	5 to 35			
		Transport/storage	-10 to 50			
	Humidity [%]	- Non-condensing – 25 to 80				
	Air pressure [hPa]	700 to 1060 Normally composed atmospheric air				
Dimensions [cm]						
Bed surface nominal size	90 x 190	100 x 200	100 x 220	120 x 200	120 x 220	140 x 200
Outer dimensions	103 x 196	113 x 206	113 x 226	133 x 206	133 x 226	153 x 206
Height adjustment (from floor to upper edge of bed surface frame)	40 to 90					
Side bar height for bed surface with metal mesh	36.8					
Side bar height with side bar height extender (accessory)	50.8					
Castor diameter	12.5 (with individually arrestable castors)					
Adjustment angle [°]						
Back part	0 to 70					
Thigh part	0 to 40					
Lower leg part	0 to 21					
- With thigh part set to max.	-21 to 15 (at leg high level/knee bend)					
Weights [kg]						
Empty weight w/o side bar	122 (or higher, depending on design)					
Separate weights	< 50					
Wood side bar (4 slats)	approx. 12 (for a bed surface length of 200 cm)					
Uplifter	up to 100 cm bed surface width [kg]			from 120 cm bed surface width [kg]		
Maximum load	80					
Individual weight	6.5			8.0		
Infusion holder (accessory) [kg]						
Maximum load (suspended load)	2					
Individual weight	0.140					
Additional information on the product						
Materials used	<ul style="list-style-type: none"> <li>- Steel (powder-coated or galvanised)</li> <li>- Commercially available plastics (POM, ABS, PP, PVC, PA6.6)</li> <li>- Rubber</li> <li>- Wood (varnished or covered in decorative film)</li> <li>- MDF boards covered in decorative film</li> <li>- Aluminium (anodised)</li> </ul>					
Sound pressure level	< 53 dB(A) at distance of 1 m					

Electrical data		ilcon GmbH
Mains plug	Input	230 V ~ (AC); 50 Hz; max. 2 A
	Output	24 V = 5 A per plug
Protection class		II
Protection type		IPX4
Switch-on cycle	On-time	Max. 15% or 2 minutes continuous operation
	Switch-off duration	Min. break 12 minutes
	Switching cycles	max. 5 per minute
Battery (emergency lowering)		9 V block battery (alkaline manganese block battery type 6LR61)



The product fulfils the requirements of the RoHS II, REACH and WEEE regulations/directives, among other requirements.

All parts and data are subject to constant further development and may therefore be different from the information shown in this document.

Notes:

Notes:

Enter the data for your product here:


- Type:**
- aks-L4
  - aks-L5
  - aks-D4 low entry
  - aks-B4 compact
  - aks-S4
  - aks-SB L
  - aks-SB XL
  - aks-SB XXL
  - aks-B4 L
  - aks-B4 XL
  - aks-B4 XXL

- Bed surface:**
- Sprung slats
  - Metal mesh

- Version:**
- Knee bend
  - Foot-end lowering

**UDI** (01)042518187 \_ \_ \_ \_ \_

**SN** \_\_\_\_\_

 Year \_\_\_\_\_ Month \_\_\_\_\_

**First time use:** Year \_\_\_\_\_ Month \_\_\_\_\_

**Authorised dealer:** Name \_\_\_\_\_  
Street \_\_\_\_\_  
Postcode/town \_\_\_\_\_  
Telephone number \_\_\_\_\_

Notes:



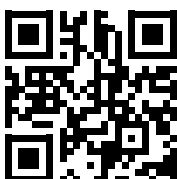
aks Aktuelle Krankenpflege Systeme GmbH  
Antwerpener Straße 6  
D-53842 Troisdorf

📞 +49(0)2241/9474-0

📠 +49(0)2241/9474-88

✉️ aks@aks.de

🌐 www.aks.de



Reprints whether in whole or in part are only allowed with prior permission by the publisher.  
All rights reserved, particularly the right to make technical amendments. Printing errors excepted.