



clino[®] XL/clino[®] e XL

Patient hoist

Instructions for use

Translation of the original instructions for use



Date: 2021-05-31 | Version 01
"Certified quality management system for the development, production and distribution of equipment and accessories for patient positioning and patient transport"



TABLE OF CONTENTS

1	Introduction	4
1.1	Explanation of the symbols used	6
2	Intended use	7
2.1	Intended purpose	7
2.2	Indication	8
2.3	Contraindication	8
2.4	Side effects	8
3	Safety instructions	9
3.1	Explanation of the groups referred to	9
3.2	General safety instructions	11
3.3	Safety instructions for the operator	13
3.4	Safety instructions for the user	15
4	Scope of delivery	16
5	Product overview	17
6	Assembly	19
6.1	General assembly instructions	19
6.2	Assembly of the patient hoist	20
6.3	Accessories: wall charging station – assembly	23
7	Commissioning	24
8	Operation	25
8.1	General operating instructions	26
8.2	Castors	27
8.3	Manual control unit	28
8.4	Spreading	29
8.5	Emergency stop button	30
8.6	Emergency lowering	31
8.7	Battery pack	32
8.8	Shutdown times	36
9	Patient transport	37
9.1	Instructions for use	37
9.2	Lifting from a lying position	39
10	Accessories/combinations	42
11	Troubleshooting	46
12	Cleaning/disinfecting	47
12.1	General cleaning and disinfecting instructions	48
12.2	Cleaning by the user/operator	49
12.3	Disinfection by the user/operator	49
12.4	Approved disinfectants and disinfection methods	49
13	Storage	50
13.1	Shutdown	51
13.2	Folding away	51
14	Reuse	53

15 Service life	53
16 Disposal	54
17 Warranty	56
18 Declaration of conformity	56
19 Maintenance	57
19.1 General maintenance instructions	57
19.2 Maintenance schedule: Inspection by the operator	59
19.3 Maintenance schedule: Inspection by the user	66
20 Product labelling	68
21 Technical data	73

1 Introduction

Dear customer,

Thank you for choosing an aks GmbH product. We appreciate your vote of confidence.

Read the instructions for use in full before using the product for the first time and before each reuse, in order to avoid damage or risks due to misuse. The instructions contain important information and notes that are necessary for proper use of the product.

If you have queries, particularly regarding the safety instructions, please contact your authorised dealer. Do not use the product until all matters have been clarified. This is to prevent injuries and damage due to incorrect use.

Keep these instructions for use within reach of the user and include them with the product if it passes to another owner.

We reserve the right to make changes and amendments. The text and illustrations may therefore not fully match the delivered product.

If you have any difficulty reading these instructions for use (e.g. due to the font size), you can always download the current version of these instructions for use as a PDF document from the aks website¹. Open the PDF document and adjust the display on your screen according to your needs.

Using the product means a better quality of life for the patient and makes work easier for the user.

This product is not permitted for use in the **United States of America** or **Canada**. The distribution and use of the product in these countries, including any distribution or use by third parties, is prohibited by the manufacturer.

1



You can find the latest version of the instructions for use in the download area on the aks website.

The **clino[®] XL patient hoist** (also referred to in the following as the product¹) offers you greater mobility and independence. It helps users to lift and move (transfer/relocate) patients. The mature technology and the convenient configuration ensure safe use.

The product is available in the following variants:

- clino[®] XL (mechanical spreading)
- clino[®] e XL (electric spreading)

Among other things, the variants are distinguished by the following features:

- Max. load capacity 185 kg
- Robust and safe design, folds up
- Easy to manoeuvre
- Spreadable chassis (to increase stability, among other things)
- Electric motor operated lifting function
- 24 V system with a removable battery pack
- Charger with charge status indicator
- Acoustic warning signal to protect against deep discharge of the batteries in the event of actuation of the manual control unit
- Electrical and Mechanical emergency lowering, emergency stop switch in the event of electric faults
- With optional separate wall charging station







Using the products in combination with a suitable aks hoist sling (see chapter **Accessories/ combinations**) means a better quality of life for the patient and makes work easier for the user.

We hope the product fulfils your expectations and wish you every success in caring for your patients.



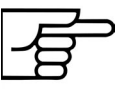

1 Product: Descriptions and instructions for all variants.
clino[®] e XL: Descriptions and instructions for the respective specified variant (in this case: clino[®] e XL).
These instructions for use may describe functions or equipment that your product does not have.

1.1 Explanation of the symbols used

For ease of reading, these instructions for use employ the following symbols to indicate important information:

	Warning of danger Indicates safety instructions that must be observed under all circumstances in order to avoid an immediate danger to life and limb (risk of serious or fatal injury).
	Warning of hand injuries Indicates safety instructions for avoiding crushing injuries.
	Warning of dangerous electrical voltage Indicates safety instructions that must be observed in order to avoid danger through electrical voltage that may result in serious or fatal injury.
	Keep dry Keep away from spray water and do not use high-pressure jet cleaners.
	Never pull on the lift drive Applying lateral forces increases the risk that is always present when lifting/uprighting and transferring people.
	Safety notice Indicates information concerning safe use of and safe work on the product.
	Information Indicates useful and important instructions and information.

In these instructions for use, the following symbols, amongst others, are used to label medical devices:

	Observe instructions for use
	Production batch number, batch
	Article number
	Serial number
	Dimensions of the product

For more information on labelling, please refer to the chapter on **Product labelling**.

2 Intended use

The products are Class I active medical devices according to Regulation (EU) 2017/745, Annex VIII.

The products are suitable for domestic use as well as for use in inpatient facilities. The products are intended for use by a trained caregiver (user). The products may be used in wet areas. This includes the toilet or the bathroom, for example. This does not include using the patient hoist under the shower.



See the rating plate or the chapter on **Technical data** for the maximum permitted load.

See the chapter on **Technical data** for the climatic conditions.

The products are suitable for reuse (see chapter on **Reuse**). Intended use further includes reading and observing these instructions for use as well as performing the inspections and maintenance tasks in accordance with the maintenance schedule (see the chapter on **Maintenance**).

2.1 Intended purpose

The products are intended for holding, transporting and changing the position of patients with restricted mobility.



They may only be used in combination with a matching aks hoist sling (see chapter **Accessories/combinations**).

The products are designed exclusively for holding patients, transporting them across short distances, and changing their position. As standard, the patient is picked up in a sitting position. If an aks tandem spreader bar / aks horizontal transport spreader bar with an 8-point attachment is used together with an aks horizontal transport sling / aks horizontal transport sling with 8-point attachment, the patient can also be picked up in a horizontal position. It is even possible to pick up a patient from the floor.

The transfer and change of position may only be carried out when the patient is in either a standing or a horizontal position.



The products are intended for short-time use without contact with injured skin.

The products are not a means of transport. The products are designed to facilitate a change of position (transport over short distances) performed by a trained helper/carer. The products may only be used on flat and level ground on a single storey (inside the patient's residence / sphere of activity).



Read and observe the instructions for use. Only use the product in accordance with the intended purpose as described. Any other use is prohibited.



2.2 Indication

The products are intended for patients who, due to an illness, injury, disability or their age, suffer from reduced mobility.

2.3 Contraindication



Pathologies such as osteogenesis imperfecta, advanced osteoporosis, spinal damage, mental confusion, epileptic fits, sensitivity to contact pain or generalised oedemas in the contact area may be contraindications. Furthermore, missing extremities or function restrictions of the musculoskeletal system (e.g. paraplegia) can rule out use.

Pathologies associated with spastic paralysis may be contraindications. Ensure that any affected extremities of the patient are supported/protected; these patients are at increased risk.

The products are not intended for contact with injured skin.

2.4 Side effects

There are currently no known side effects.

3 Safety instructions



The safety instructions apply to all and any persons who perform work in any way with or on the product (incl. accessories). Where a specific group is addressed, this does not exclude any other persons.

Read and observe the safety instructions. The safety instructions comprise text or a combination of a symbol with text. The symbols used are not substitutes for the text for the safety instructions. Read the text of the safety instructions and follow it precisely.

3.1 Explanation of the groups referred to

The operator is the person who is in possession of the medical device, i.e. any natural or legal entity whose employees operate/use the medical device. The operator does not necessarily need to be the proprietor of the medical device (e.g. medical supply store, authorised dealer, health insurer). The operator bears principal responsibility for the organisational measures and for ensuring compliance with national regulations.



The user must be trained in the safe handling of the medical devices described in these instructions for use (incl. accessories) prior to their first use and every reuse. **It is the duty of the operator (e.g. the responsible medical supply store/authorised dealer) to ensure that the user receives the proper training.**

If the medical device is to be used by relatives of the patient who are responsible for the patient's care¹, the operator must inform said relatives of the circumstances in which they should ask a health care professional for advice, e.g.:

- If they observe any health problems in the patient that are associated with the product (incl. accessories).
- If they are unsure regarding a potential use of the product (incl. accessories).

In Germany, the EU Medical Devices Adaptation Act (MPEUAnpG) applies, and in particular the Medical Devices Implementation Act (MPDG) and the Medical Devices Operator Ordinance (MPBetreibV) contained in Article 1. The corresponding national laws, regulations and requirements are applicable in other countries.

Qualified personnel are persons who, through their training and practical activities, possess the required specialist knowledge and means to properly maintain [assemble, perform commissioning, maintain, inspect, repair, treat (clean/disinfect) and dispose of] medical devices – those defined in these instructions for use – (incl. accessories) and who are capable of performing and documenting the required tasks within the necessary scope.

Qualified electricians as defined in the German accident prevention regulations DGUV Specification 3; persons who, through their specialist training, skills and knowledge as well as through knowledge of the valid regulations, are capable of performing the assigned work and assessing potential hazards.

The qualified electrician must further be trained in handling medical devices and possess knowledge of the specific product.

¹ Relatives who care for the patient do **not** usually possess formal health care training.

Electrically instructed persons are persons who have been instructed and, if necessary, trained by a qualified electrician regarding their assigned tasks and the possible hazards in the event of improper behaviour, as well as regarding the necessary safety equipment and safety measures.

In the context of these instructions for use, the word **user** refers to the person who uses (operates) the medical device (incl. accessories) on the patient. The user will be taught the skills and knowledge required to do this by means of proper training in the use of the product provided by the operator, in accordance with these instructions for use.



The user must be physically and mentally able to perform the following activities in relation to the medical devices (incl. accessories) described in these instructions for use:

- Use them in accordance with their intended purpose.
- Set them up in accordance with their intended purpose (e.g. carry out permissible adaptations/modifications in line with the intended use and the permissible combinations).
- In case of unusual noises or obvious damage: shut them down, mark them clearly as “Out of order” and inform the appropriate qualified personnel.

Users must be able to assess the patient’s clinical condition and to take specific action to protect the patient from danger. If relatives take over responsibility for the patient’s care, these relatives must be in a position to consult a health care professional when in doubt.

Prior to each use of the medical devices (incl. accessories) described in these instructions for use, the user must ensure that the products are in good condition and full working order, and observe the instructions for use.

These instructions for use employ the term **patient** to refer respectively to any person who, due to their illness, injury, disability or age, requires care or to any person who will be relocated using the device.

For the sake of better legibility, only the male form (he/his) is used in the texts . The female form is of course always implicit in such use.

3.2 General safety instructions



Training is required in the proper handling of the product (incl. accessories). The training must be documented in an appropriate form. The training must be conducted on the product itself in accordance with the instructions for use, and must observe all the contents of said instructions for use.

Observe the permissible maximum load (see chapter on technical data). Only load the combination, consisting of patient hoist, spreader bar/lifting arm and hoist sling, with the lowest permissible maximum load. This means that if there is a difference between the permissible maximum loads of the individual elements, the lowest permissible maximum load must be observed. If this instruction is not observed, safe operation can no longer be guaranteed. Furthermore, there is an increase to the risk that is always present when lifting/uprighting and transferring people.

Note the information on attaching the sling loops (see chapter **Preparation** in the instructions for use for the hoist sling in question). Failure to observe this requirement may cause the patient to fall, and thus result in severe or even fatal injury to the patient.

Do not use a damaged or heavily worn product/accessories. Failure to observe this requirement may cause the patient to fall, and thus result in severe or even fatal injury to the patient.

In addition to the periodic checking by suitable qualified personnel, check that the product and its accessories are in a safe state before each use (see chapter on Maintenance, section **Maintenance schedule: Inspection by the user**). Do not continue using the product (or its accessories) if you notice unusual noises or damage. If you have any doubts about the safety of the product or the accessories, do not use them. Mark the product/accessories clearly as "out of order" and inform your authorised dealer immediately.

Observe the specifications regarding cleaning/disinfecting (see the chapter on **Cleaning/disinfecting**).

When cleaning/disinfecting the product, note that the individual components could be infectious or contaminated. Take suitable precautions for your own safety. Use suitable packaging/labelling to ensure that the product/accessories can be transported without any risk to third parties.

Keep the product (incl. accessories) away from direct sunlight. Protect the product from intense heat (e.g. heating, stoves) **or open flames** (e.g. fireplace, cigarette ember, candle) **and other heat effects.**

Protect the product (incl. accessories) from pointed and sharp-edged objects and surfaces (this also includes the claws and teeth of pets). There is a risk of damage.

Check the suitability of the product (incl. accessories) for the patient at regular intervals (e.g. in case of physical changes [amputation] or weight gain/loss). In doing so, take account of the special characteristics of the patient. Ensure that professional assessment in the form of a risk analysis is ensured, so that the correct size, correct type and correct form of hoist sling are used for the patient. Match the functional characteristics of the hoist sling to the specific disabilities and functional limitations of the respective patient. Potential contraindications must be observed in this regard.



Use the product (incl. accessories) in line with its intended purpose only and always observe the instructions for use.



Lifting/uprighting and transferring patients always involves a certain risk. Explain any potential risks to the patient and brief them to ensure that their behaviour does not generate any additional risks. There is a higher risk for persons who are mentally deranged or extremely fragile. Strictly comply with the safety instructions specified here in order to minimise the residual risk. Violent movements or holding on to objects during the transfer can result in hazards.

For hygiene reasons, always use the hoist sling for the same patient.

Use only original aks accessories/spare parts in order to avoid danger (see the chapter on **Accessories/combinations**).

Do not leave children unsupervised in the vicinity of the product. Press the emergency stop button (see chapter on Operation, section **Emergency stop button**) or remove the battery pack (see chapter on operation, section **Battery pack**). The patient hoist is not a toy!

If the product is not used for an extended period, observe the requirements for storage in the chapter on **Storage**.

Faults due to the use of mobile communications devices cannot be completely ruled out. Note that possible electromagnetic or other influences between the product and other equipment cannot be ruled out. If there is a risk of interference, remove the interference sources or do not use the product.

When using mobile communications equipment, maintain a safety distance of at least 3.3m. This avoids any potential electromagnetic interference between the communications devices and product and guarantees safe operation of the product. – See position paper of the German Federal Institute for Drugs and Medical Devices (BfArM) (reference no.: 9/0508) – If in doubt, press the emergency stop button (see chapter on Operation, section **Emergency stop button**).



The product's electrical components have been tested by an external, independent test institute to ensure the safety of the product. Nevertheless, hazards may arise in case of unintended use.

The product's electrical components have protection type IPX4; this must be maintained throughout the entirety of the product's lifecycle. If an electrical component is damaged, the protection type will no longer apply. In such cases, the defective electrical component must be replaced immediately. Cease use of the product and mark it clearly as "Out of order". Inform your authorised dealer immediately. Failure to observe these requirements may result in moisture/liquid getting into the product. There is a risk of short circuit due to contact with moisture/liquids.



If you experience any serious incidents² involving the product (incl. accessories), please contact aks GmbH and the relevant national authorities without delay.

2 "Serious incident" means any incident (involving the product (or its accessories) that directly or indirectly led, might have led or might lead to any of the following: (the death of a patient, user or other person, or the temporary or permanent serious deterioration of a patient's, user's or other person's state of health).

3.3 Safety instructions for the operator



Prior to initial use and every reuse, train the user on the product itself (incl. accessories) on the basis of the instructions for use, explain the safety instructions, test the effectiveness of the training, and properly document said training. Make the user aware of the hazards that may arise in case of unintended use of the product (incl. accessories).

The product is not EX-protected and must not be operated in potentially explosive areas. It must not be operated in the vicinity of flammable, narcotic mixtures of air, oxygen or nitrogen oxides.



You as the operator must ensure (e.g. by means of corresponding instructions and precautions) that no mechanical loads are applied to the power line during charging (e.g. kinking, shearing, driving over the lines with the product itself or with equipment trolleys, loads during room cleaning etc.). This also applies to power lines for other equipment which is used in combination with the product.

Make sure that the electrical installation of the room/area in which the product is connected and operated complies with the state of the art.



Only allow suitable qualified personnel to perform the assembly, commissioning, maintenance, treatment (cleaning/disinfecting) and repair of the product (incl. accessories).

Make sure that the user is physically and mentally able to perform the following activities in relation to the medical devices (incl. accessories) described in these instructions for use:

- Use them in accordance with their intended purpose.
- Set them up in accordance with their intended purpose (e.g. carry out permissible adaptations/modifications in line with the intended use and the permissible combinations).
- In case of unusual noises or obvious damage: shut them down, mark them clearly as "Out of order" and inform the appropriate qualified personnel

Inform the user that, in addition to the periodic checking by suitable qualified personnel, the user themselves must check that the product and its accessories are in a safe state before each use (see chapter on Maintenance, section **Maintenance schedule: Inspection by the user**).

Make sure that the user possesses the skills and knowledge required to check the suitability of the product (incl. accessories), to assess the patient's clinical condition, and to take specific action to protect the patient from danger.



If relatives take over responsibility for the patient's care, check that these relatives are in a position to consult a health care professional when in doubt. Explain to the users when they should ask a health care professional for advice, e.g.:

- If they observe any health problems in the patient that are associated with the product/accessories.
- If they are unsure regarding a potential use of the product/accessories.

Use only original drive components in order to avoid danger. Never use drive components produced by other drive manufacturers. Never create systems comprising a mixture of different brands (see chapter on Technical data, section **Electrical data!**)



When using the product, comply with all the provisions of the EU Medical Devices Adaptation Act (MPEUAnpG), and in particular the Medical Devices Implementation Act (MPDG) contained in Article 1, and all additionally applicable legal regulations as well as with the applicable work health and safety regulations, accident prevention regulations and the general provisions concerning the handling of technical devices.

Note that this product is a medical device and the Medical Devices Operator Ordinance (MPBetreibV) are binding for the operator in Germany.

The corresponding national regulations apply in other countries. For use in countries other than Germany, observe the respective applicable national laws, regulations and provisions.

3.4 Safety instructions for the user



Arrange for the operator (e.g. your responsible medical supply store/authorised dealer) to train you in the safe handling of the product (incl. accessories) using the product itself, in accordance with the instructions for use.

Only use the product (incl. accessories) if you have been instructed about its handling – including the safety instructions – and you have the corresponding expert knowledge to assess the suitability of the product (incl. accessories) for the patient. If in doubt, ask a health care professional for advice. If you have queries, particularly regarding the safety instructions, please contact the operator. **Do not use the product (incl. accessories) until all matters have been clarified. This is to prevent injuries and damage due to incorrect use.**



Prior to each use of the medical devices (incl. accessories) described in these instructions for use, ensure that the **products (incl. accessories) are in good condition and full working order** (see chapter on Maintenance, section **Maintenance schedule: Inspection by the user**). Observe the instructions for use.

Observe the permissible maximum on-time. If this is exceeded, safe operation can no longer be guaranteed (see the chapters on **Commissioning** and on **Technical data**).

4 Scope of delivery

The product has already been inspected at the factory to ensure completeness and freedom from defects. Nevertheless, check the product immediately after receipt for possible transport damage.

After removing all individual parts, check the completeness of the scope of delivery using the delivery note. If not all the individual parts of the scope of delivery are present, contact your authorised dealer.

The product's¹ scope of delivery includes:

Delivery in cardboard box (here clino® XL)

Scope of delivery	Cardboard box	Content
aks patient hoist clino® XL	clino® XL	<ul style="list-style-type: none"> 1 clino® XL 1 Battery pack (removable) 1 Manual control unit 1 Bag containing: <ul style="list-style-type: none"> 1 Charger with European plug (optional with UK plug) 1 Instructions for use 1 Spreader bar (depending on order) <ul style="list-style-type: none"> - The horizontal transport spreader bar with 8-point attachment is packaged separately upon delivery - 1 Hoist sling (optional, depending on order)

¹ Depending on the order, model name: clino® XL, clino® e XL

5 Product overview

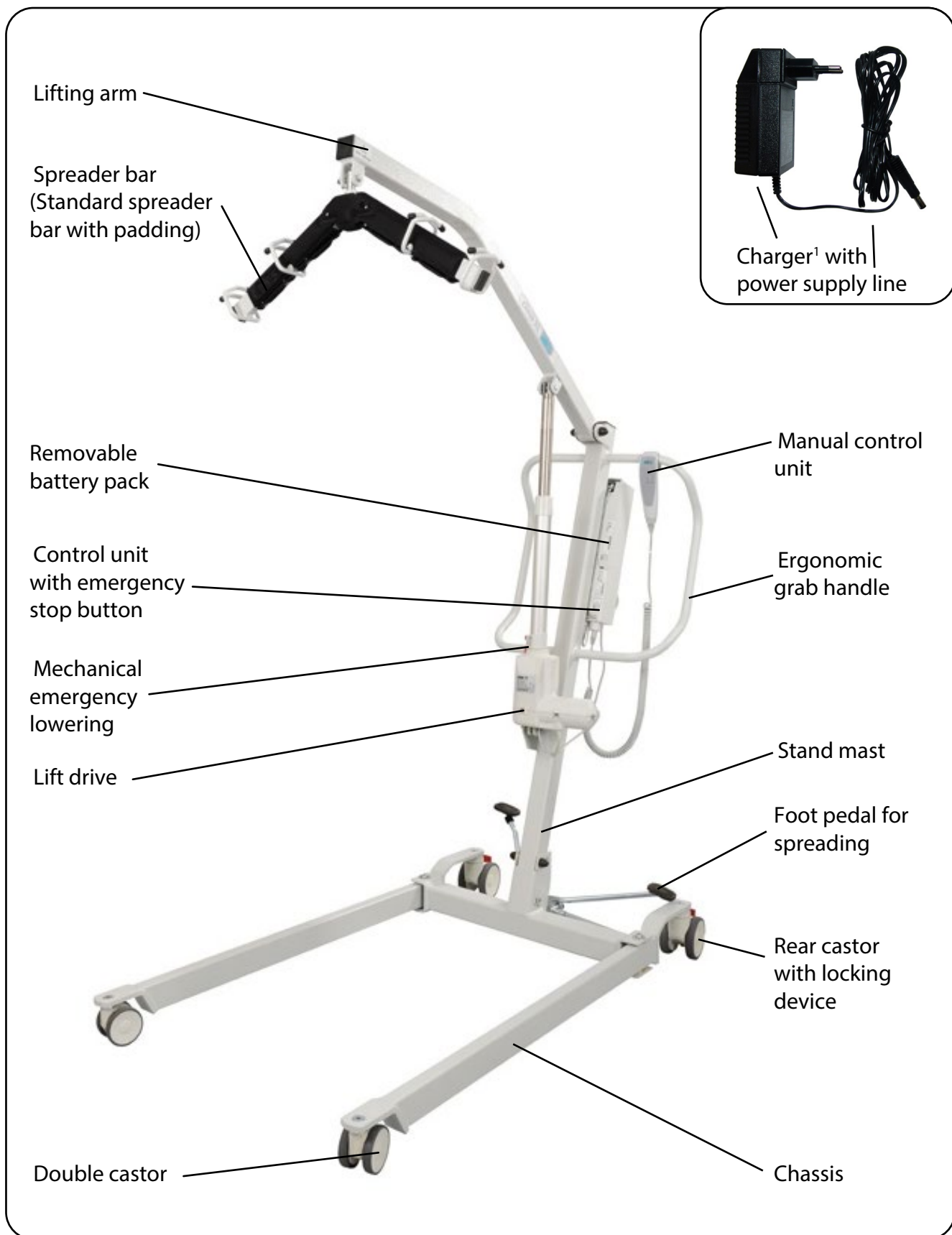

Fig. 5.01 – clino[®] XL

¹⁾ Figure shows European plug

The product is a mobile patient hoist with an electric lifting and lowering function.

The base of the patient hoist is the U-shaped chassis with four castors; the two rear castors (on the operator's side) can be locked. With mechanical spreading, the chassis can be spread mechanically using a foot pedal; with electric spreading, the chassis can be spread electrically with a spreader drive using the manual control unit. This can be required to adjust the chassis to the width of the seating of the patient or to increase the stability.

The stand mast mounted on the chassis can be folded forwards for purposes of transporting or storing the patient hoist. An ergonomic grab handle attached to the stand mast makes it easy to move the patient hoist.

The control unit with an emergency stop button and a removable battery pack are located on the stand mast.

The movable lifting arm is mounted at the top end of the stand mast. It can be raised and lowered electrically and continuously by means of a lift drive. The lift drive connects the stand mast with the lifting arm and is adjusted with the manual control unit. The lift drive is also equipped with a mechanical emergency lowering function. Different aks spreader bars (see chapter **Accessories/ combinations**) can be mounted on the lifting arm to attach the different aks hoist slings.

The necessary electrical energy is provided by a powerful 24 V removable battery pack on the control unit. The battery pack can be charged while it is attached to the patient hoist. There also the option of charging it in a wall charging station that is available as an accessory.

6 Assembly

6.1 General assembly instructions

Locking plate



aks patient hoists are secured at several connection points with a pin with a locking plate. This locking plate enables fast installation and dismantling of individual components without tools, particularly when assembling and folding up the patient hoist and when attaching or replacing a spreader bar.



The locking plate is correctly installed when it audibly engages and can be freely turned in the groove of the pin. Fig. 6.1.01 Shows the correct position and Fig. 6.1.02 shows an incorrect position.

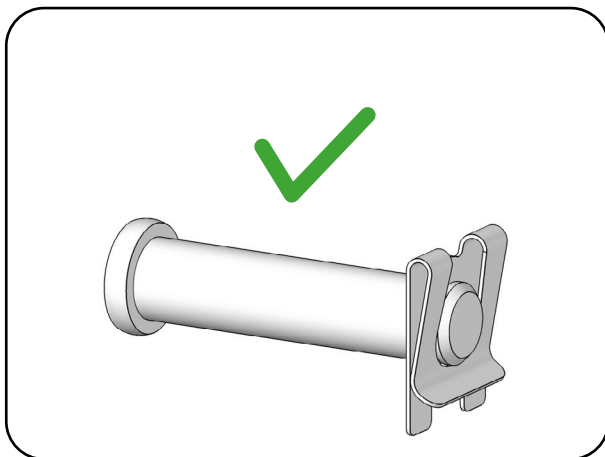

Fig. 6.1.01 - Locking plate installed correctly

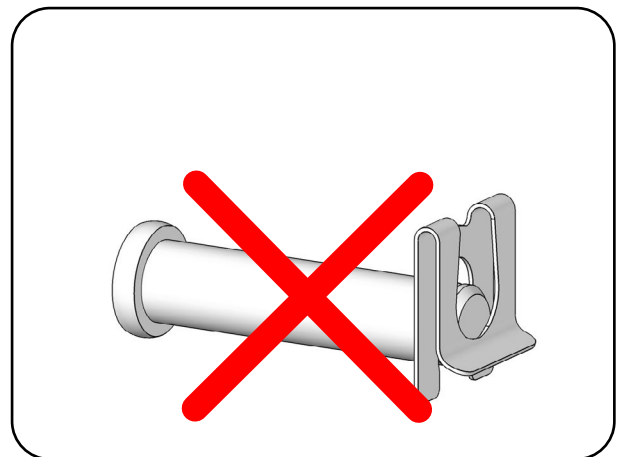

Fig. 6.1.02 - Locking plate installed incorrectly



Observe the installation position of the pin and assemble the locking plate according to Fig. 6.1.01. Failure to observe this requirement may cause the patient to fall, and thus result in severe or even fatal injury to the patient.

The correct assembly and dismantling of the locking plate is described below.

Mounting the locking plate

Push the locking plate into the groove at the end of the pin (Fig. 6.1.03). In doing so, the curved end of the plate slides over the chamfer of the pin.

Dismantling the locking plate

Pull the curved end of the plate back a little (1) and push the locking plate out of the groove of the pin (2) (Fig. 6.1.04).

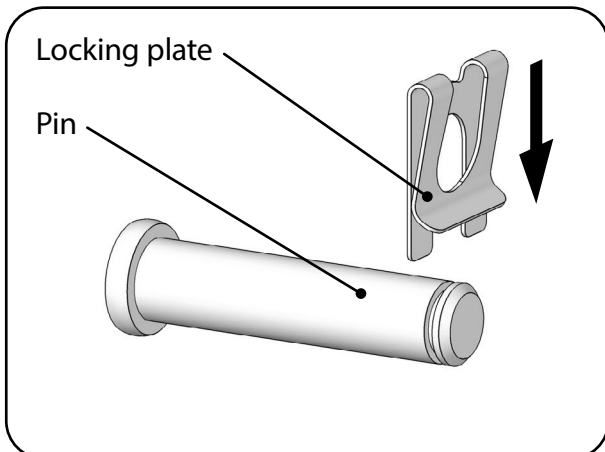

Fig. 6.1.03 – Mounting the locking plate on the pin

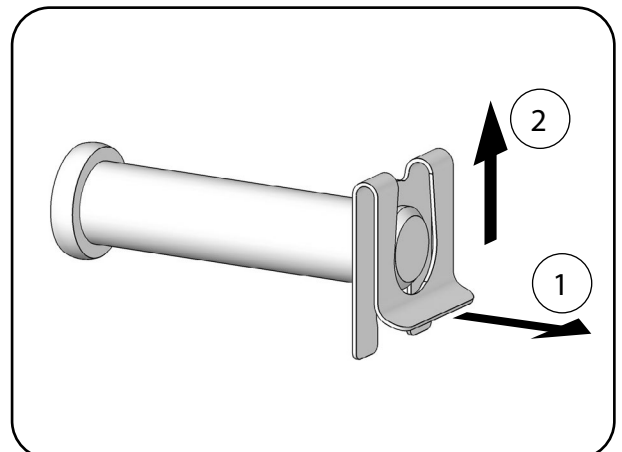

Fig. 6.1.04 – Dismantling the locking plate

6.2 Assembly of the patient hoist

Install and remove the product in line with the specifications in these instructions for use, observe the safety instructions and use protective materials placed on the ground (e.g. cardboard/packaging material) to prevent damage to the flooring. Remove the patient hoist from the packaging. Retain the packaging for future transport or storage of the product.



Inspect the product before and during assembly for damage and defects.

If you have established that the delivery is complete based on the **Scope of delivery** chapter in this manual and that the delivery is undamaged, proceed with the assembly as follows:

1. Activate the emergency stop button (see chapter on Operation, section **Emergency stop button**) by pressing it, if it has not been pressed.
2. Place the chassis with the castors on the floor (Fig. 6.2.01).
3. Brake the two rear castors on the operator side by activating the foot lever (Fig. 6.2.01); see chapter on Operation, section **Castors**.



Always brake both rear castors in order to prevent the product from accidentally rolling away.

4. Remove the locking plate and then remove the pin from the hole for the transport lock on the stand mast holder (Fig. 6.2.02).

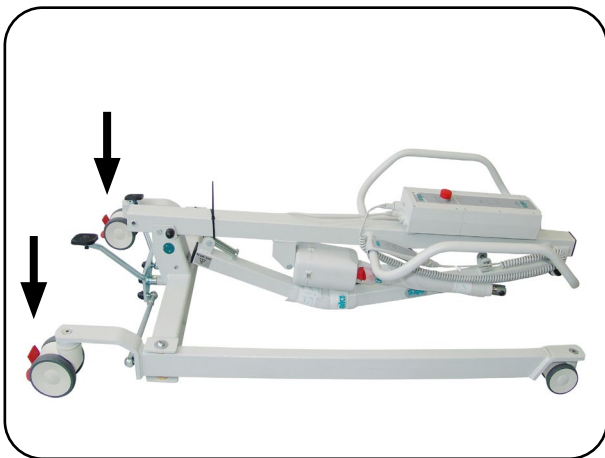

Fig. 6.2.01 - Chassis

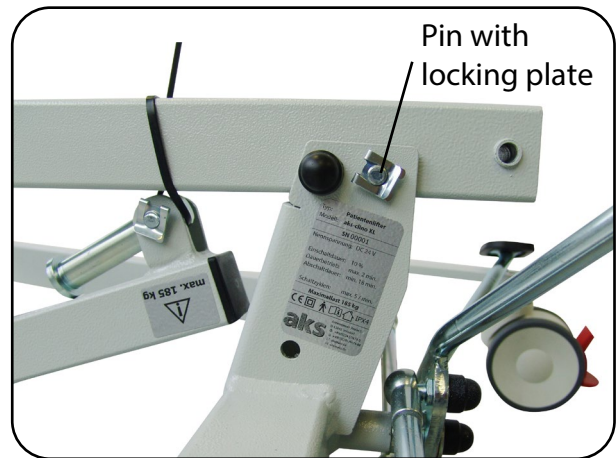

Fig. 6.2.02 - Stand mast holder

5. Set the stand mast upright (Fig. 6.2.03) and fully align the hole on the stand mast with the hole on the stand mast holder. Then secure the stand mast again using the pin and the locking plate (Fig. 6.2.04).
6. Remove the cable tie that holds the lifting arm in place on the stand mast as a transport lock (Fig. 6.2.03).

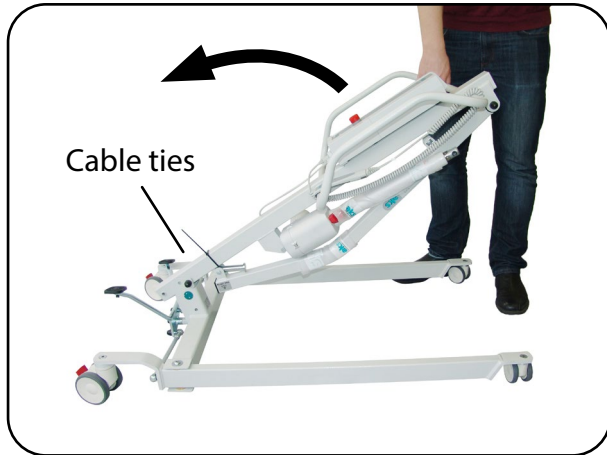

Fig. 6.2.03 - Setting up the stand mast

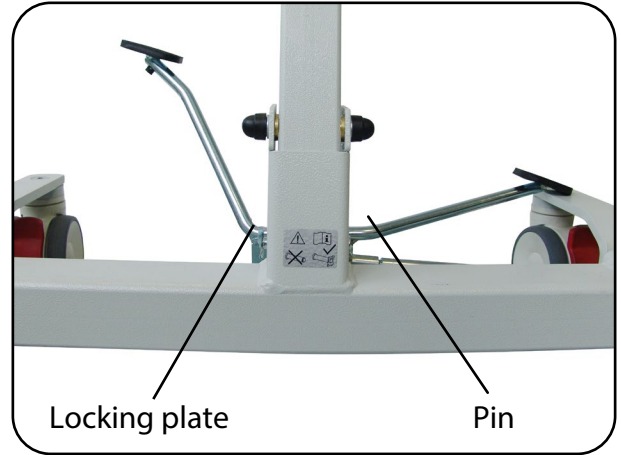

Fig. 6.2.04 - Stand mast holder

7. Remove the bolt with the locking plate from the retaining plate on the lifting arm (Fig. 6.2.06).



When installing the lift drive, make sure that the pin with locking plate is correctly fastened (see chapter on Assembly, section General assembly instructions)!

8. Raise the lifting arm and fully align the hole of the lift pipe (fork head) with the hole of the retaining plate. Fasten the lift drive to the retaining plate of the lifting arm by inserting the pin (Fig. 6.2.06).
9. Secure the pin with the locking plate (Fig. 6.2.06). To do so, push the locking plate into the groove at the end of the pin. In doing so, the curved end of the plate slides over the chamfer of the pin.

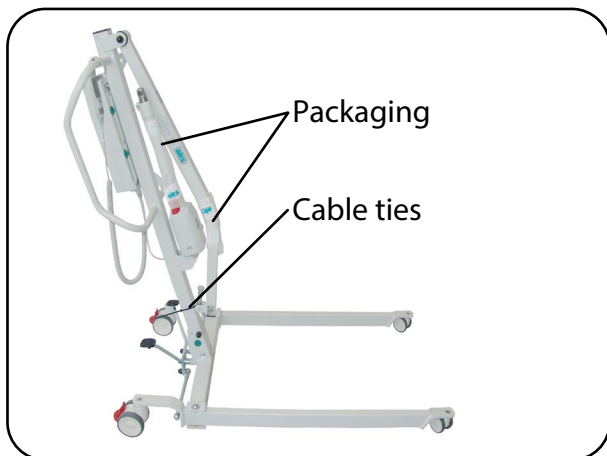

Fig. 6.2.05 - Stand mast set upright

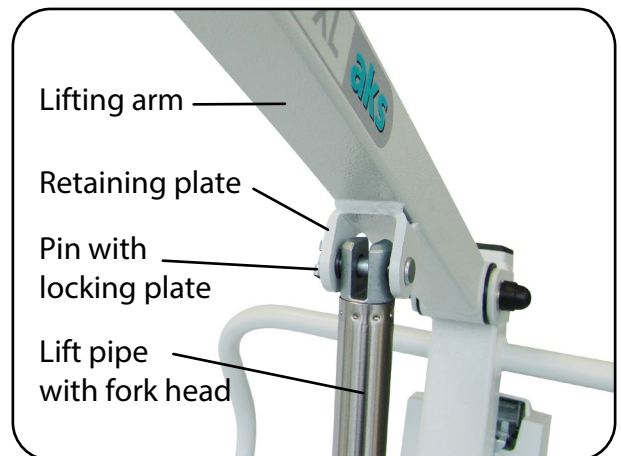

Fig. 6.2.06 - Assembly of the lift drive

10. To mount the spreader bar, open the bar padding (plate). Remove the locking plate and then remove the pin from the hole on the end of the lifting arm. This separates the retaining bolt with collar from the lifting arm (Fig. 6.2.07).
11. Make sure that the sliding washer is on the retaining bolt with collar.
12. Then insert the retaining bolt with collar together with the sliding washer from below through the holding sleeve of the spreader bar (Fig. 6.2.07). The sliding washer lies on the collar of the retaining bolt.
13. Attach the spreader bar with the inserted retaining bolt with collar to the lifting arm by inserting the bolt through the holes on the end of the lifting arm. Secure the bolt with the locking plate and close the bar padding (plate) (Fig. 6.2.08).

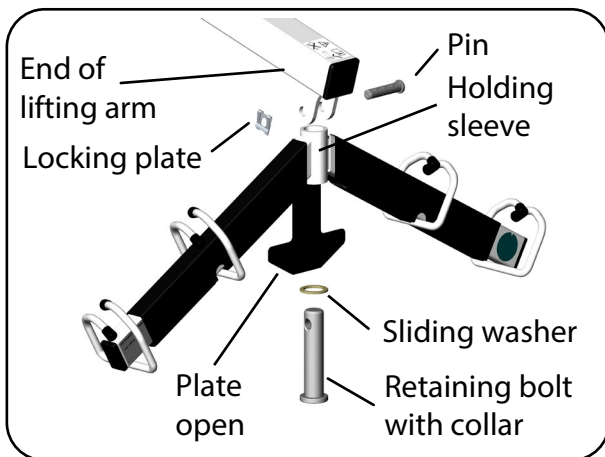

Fig. 6.2.07 - Assembly of the spreader bar

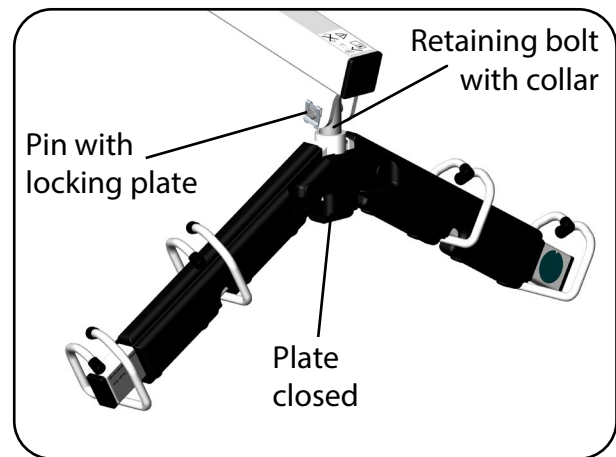

Fig. 6.2.08 - Spreader bar installed

14. Remove the packaging from the lift drive and lifting arm (Fig. 6.2.05).
15. Release the brakes on the two rear castors on the operator side by activating the foot lever (Fig. 6.2.01); see chapter on Operation, section **Castors**.
16. To use the equipment for the first time, proceed as described in the chapter **Commissioning**.

6.3 Accessories: wall charging station – assembly

The wall charging station combined with a second battery pack enables continuous use of the product, particularly in the in-patient area. Before commissioning, the wall charging station should be installed on a wall.

Inspect the product for damage and defects before assembly. Once you have established that the product is undamaged, proceed with the assembly as follows:

1. Fasten the mounting rail vertically to a flat and firm wall (Fig. 6.3.02). Match the type of fastening to the wall material. Use plugs and screws according to the properties and condition of the wall.
2. Slide the charger onto the bottom part of the mounted mounting rail and fasten it with the enclosed M5x10 mm cylinder bolts (max. tightening torque 1 Nm)
3. Now plug the device plug (red) of the power supply line into the connection socket of the wall charging station. Ensure that the device plug engages and cannot be pulled out.
4. Attach the cable hook to the charger by pushing it onto the sockets from above. Hang the power supply line on the cable hook when you unplug the mains cable (Fig. 6.3.02).



Do not mount the wall charging station in wet areas. Choose a location that can be well ventilated, e.g. via a window.

The power supply line must not lie on the floor. Mechanical strains may damage the power supply line (e.g. if equipment is driven over the power supply line).

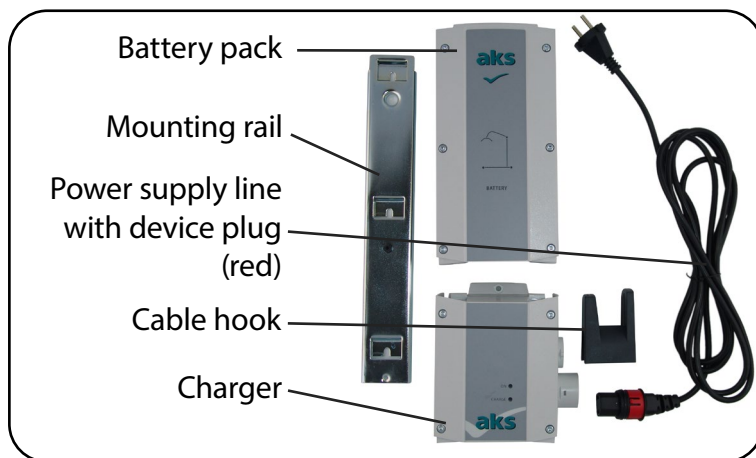

**Fig. 6.3.01 – Scope of delivery
Wall charging station accessory**

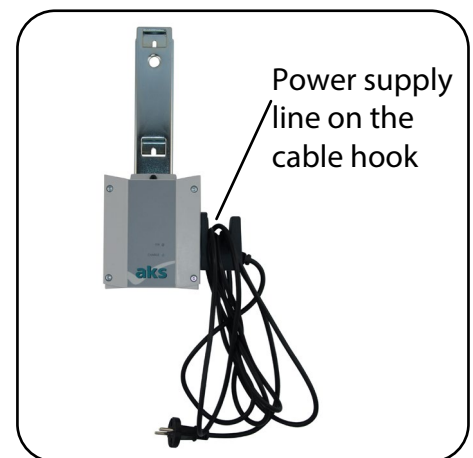

**Fig. 6.3.02 – Wall charging station
mounted upright on the wall**

7 Commissioning

Before commissioning the product for the first time, and every time it is reused, check that the product (incl. accessories) is in safe condition based on the maintenance information in the chapter on **Maintenance**. Before the product (incl. accessories) is reused, always clean and disinfect it in accordance with the instructions given in the chapter on **Cleaning/disinfecting**.



Observe the safety instructions (see chapter on **Safety instructions**).

Before the first commissioning of the product, and every time it is reassembled, the battery pack must be charged; for charging time, see chapter on Technical data, section **Electrical data**.

Perform the commissioning as follows:

1. Check the plug connections on the control unit (Fig. 7.01/Fig. 7.02):
 - 0** = Manual control unit
 - 1** = Lift drive
 - 2** = Mechanical spreading:
do not use and do not remove the dummy plug
 - Electric spreading:
Spreader drive
 - DC** = Charging socket (closed with dummy plugs)
 - 3** = Emergency stop button



Fig. 7.01 – Control unit - mechanical spreading



Fig. 7.02 – Control unit - electric spreading

2. Before using the patient hoist, charge the battery pack. To do so, proceed as described in the chapter on Operation, section **Battery pack**.
3. Unlock the emergency stop button (Fig. 7.01) – if it has been pressed – by turning it clockwise (arrow direction); (see chapter on Operation, section **Emergency stop button**).



The motorised adjustment is not suitable for continuous operation. The max. on-time of 2 minutes (with max. 5 switching cycles per minute) must not be exceeded. Once the product has been operated continuously for the maximum on-time, it must remain switched off for at least 18 minutes. Exceeding the max. on-time shortens the product's service life.



Do not operate the control unit with uncovered sockets! All sockets must have either an electrical plug or a dummy plug plugged into them. There is a risk of short circuit or fire due to contact with moisture/liquids.



Keep the product away from direct sunlight, fire and heat sources (e.g. heating, stoves etc.).

8 Operation

The products (incl. accessories) have been developed for use with an aks hoist sling. Before and during each use of the product, note the following information:



Inspect the product at regular intervals (see the section **Maintenance schedule: Inspection by the user** in the maintenance chapter).



Do not use a damaged or heavily worn product. Inspect the product in question (incl. accessories) for damage and defects before use. Failure to observe this requirement may cause the patient to fall, and thus result in severe or even fatal injury to the patient.

The prerequisites to ensure that the patient enjoys the highest possible degree of safety and comfort include selecting the right hoist sling size, the correct position of the patient in the hoist sling, the optimum suspension position of the sling loops and selection of the correct hooks on the spreader bar.

As the operator, you must train the user and make them aware of the hazards that may arise in case of unintended use of the product.

Amongst other things, you must draw attention to the following hazards/risks:

- Risk of falling due to incorrectly attached sling loops (see chapter on Preparation, section **Spreader bar of aks patient hoists** - instructions for use of the respective hoist sling)
- Risk of falling due to incorrect combination of sling loops (see chapter on Preparation, section **Sling loops** - instructions for use of the applicable hoist sling)
- Damage to the hoist sling due to incorrect cleaning/disinfecting, including washing/drying at too high temperatures, using additional brighteners/ bleach (see chapter **Cleaning/disinfecting** - instructions for use of the applicable hoist sling)



The electrical components must show no external signs of damage. In case of damage, fluids such as water and cleaning agents may get into the electrical components. This can cause malfunctions and damage to the electrical components. Do not use the components if they become damaged. Mark the product clearly as “out of order” and inform your authorised dealer immediately.

Note that protection against spray water is only guaranteed (protection type/ moisture protection) when the battery pack is attached.

8.1 General operating instructions



Only move the patient hoist using the ergonomic grab handle.

Never pull on the lift drive. Applying lateral forces not only reduces the service life of the lift drive, it also increases the risk that is always present when lifting/uprighting and transferring people. The lift drive is labelled accordingly with a sticker.



Never pull on the spreader bar / lifting arm. Applying lateral forces increases the risk that is always present when lifting/uprighting and transferring people.

Never pull the patient. Applying lateral forces increases the risk that is always present when lifting/uprighting and transferring people.

8.2 Castors

The product is fitted with four castors. The two rear castors on the operator side can be locked individually. The individual locking enables you to brake the castors and secure the product against accidentally rolling away or turning.



When releasing/arresting the castors wear sturdy shoes without open toes in order to prevent injuries to your toes. Set the foot lever to the corresponding position to release or apply the brake (Fig. 8.2.01 and Fig. 8.2.02).

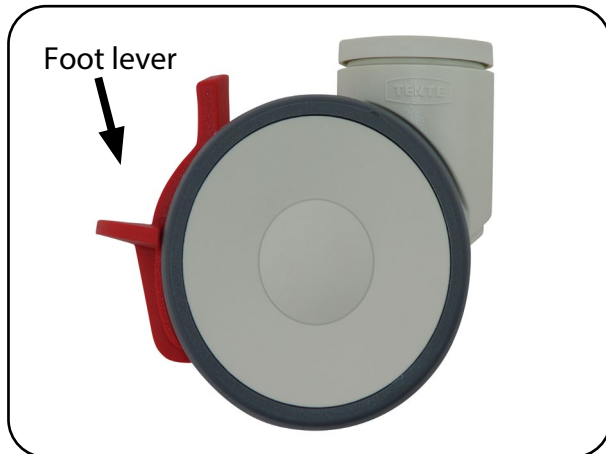

Fig. 8.2.01 – Castor released

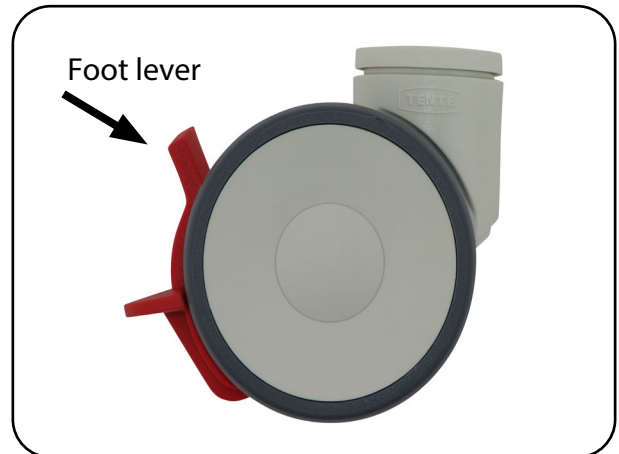

Fig. 8.2.02 – Castor arrested



In general, the patient hoist should not be braked during the lifting process. Only brake the castors if there is a risk of the patient being injured by the rolling patient hoist, e.g. when lifting up from the ground.

Brake the castors if there is a risk of the patient being injured by the rolling patient hoist. Always brake both rear castors in order to prevent the product from accidentally rolling away.

Note that there is a greater risk of the patient hoist tipping over during lifting when the castors are locked.

Do not use the product further if the locking devices / foot lever fail or spring open of their own accord.



Every time you lock the rear castors, check that both castors really are locked and that they remain locked by attempting to move the product.

Before using the product on parquet/natural wood floors, check whether the floor sealant is suitable for preventing the castors from causing damage (e.g. discolouration). The product can generally be used on tiles, carpets, laminate flooring and linoleum without any problem, though care should be taken to ensure that any damage that does occur is noticed at an early stage. aks GmbH accepts no liability for damage arising from everyday use on floors.

8.3 Manual control unit

In order to perform the electrically powered functions, press the corresponding function button on the manual control unit until the desired position is reached (Fig. 8.3.01 and Fig. 8.3.02).



Note that only one function may ever be performed at any one time with the version with electric spreading. Otherwise the electrical system can shut down and/or be damaged due to overload.



If you hear a signal tone when you press a button, this indicates that the battery pack is insufficiently charged. In this case, the battery pack needs to be charged immediately or replaced with a fully charged battery pack. A lifting/uprighting cycle that has already started may be continued to the end.

The manual control unit is equipped with a hook. When the manual control unit is not in use, hang it onto the product, where it cannot fall down unintentionally and is in easy reach at all times (see chapter on **Product overview**). Make sure that the power supply line of the manual control unit cannot be damaged by moving parts of the hoist.



When performing electric adjustments, make sure there is sufficient space for the respective movements. The adjustment range must be clear of objects, sloped ceilings and limbs. The adjustments may only be carried out by or in the presence of a person who possesses the required training.



Fig. 8.3.01 - Manual control unit mechanical spreading

Lifting the lifting arm
Lowering the lifting arm
Spreading/closing the chassis

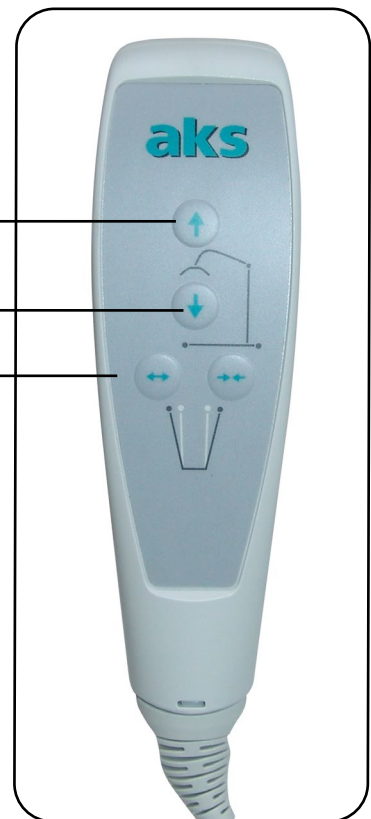

Fig. 8.3.02 - Manual control unit electric spreading

8.4 Spreading

The chassis is fitted with a spreader function. This function makes it possible, if necessary, to adjust the chassis to the width of the patient's seat or to increase the stability.



Ensure there is sufficient freedom of movement for the spreading. Make sure there are no objects or limbs within the adjustment range.



It is easier to spread the chassis if you move the product backwards and forwards slightly during spreading.

Mechanical spreading

To spread the chassis, press down on the right-hand foot pedal on the operator's side (Fig. 8.4.01). To close the chassis, press down on the left-hand foot pedal on the operator's side (Fig. 8.4.02).



Fig. 8.4.01 - Chassis closed



Fig. 8.4.02 - Chassis spread

Electric spreading

In the case of the e-variant, the chassis is spread (Fig. 8.4.03) by pressing the corresponding button on the manual control unit (see Operation chapter, **Manual control unit** section).

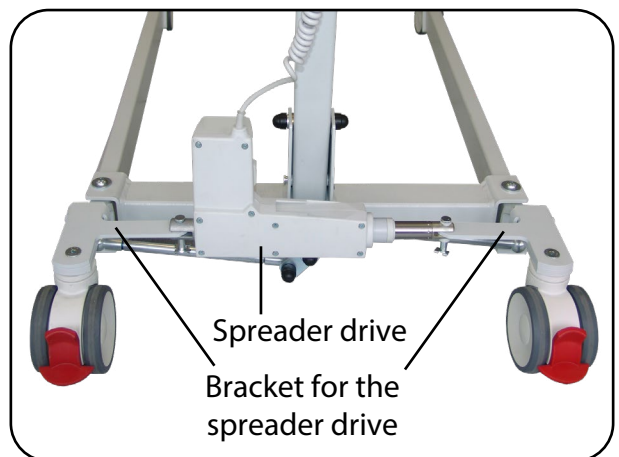

Fig. 8.4.03 - Electric spreading

8.5 Emergency stop button

The product is fitted with an emergency stop button. This allows you to interrupt electricity supply immediately in the event of an emergency.

To interrupt the power supply, press the red emergency stop button on the control unit (Fig. 8.5.01).

To restore the power supply, unlock the emergency stop button by turning it clockwise (direction of arrow).

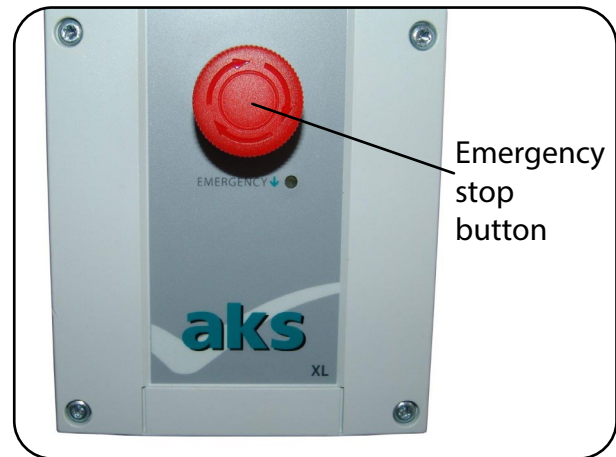

Fig. 8.5.01 – Control unit with emergency stop button



The emergency stop button must always be freely accessible.

In order to avoid injuries, the emergency stop button should be actuated in all transport situations (without a patient).

8.6 Emergency lowering

Electrical emergency lowering

The product is fitted with an electrical emergency lowering function. This enables you to lower the lifting arm when it is not possible to properly activate the lift drive using the manual control unit (e.g. fault in the manual control unit).

To carry out electrical emergency lowering, use a pen or similar object to press the "Emergency" button under the emergency stop button (Fig. 8.6.01) on the control unit.



Fig. 8.6.01 – Control unit with electrical emergency lowering

Mechanical emergency lowering

The product is fitted with a mechanical emergency lowering function. This enables you to lower the lifting arm if the lift drive is not functioning properly (e.g. fault in electrical parts, completely flat battery pack).



The mechanical emergency lowering can only be triggered under load. If there is no load (no patient), it is not possible to activate the mechanical emergency lowering. If the patient weighs less than 100 kg, an extra load has to be applied to the end of the lifting arm.

The emergency lowering must only be performed by trained users. Practice lowering under normal conditions so that you can lower the patient part safely and in controlled fashion in an emergency. You can stop the emergency lowering at any time. Before performing an emergency lowering, assess whether you need a second helper. Incorrect/uncontrolled emergency lowering can severely injure both user and patient!

To perform controlled emergency lowering, proceed step by step.

To carry out mechanical emergency lowering, pull the red trigger handle up in the direction of the arrow (Fig. 8.6.02). The lowering speed depends on how intensely you pull it and what weight is applied. The harder you pull, the faster the lift drive moves down. If you release the trigger handle, the emergency lowering stops immediately.



Fig. 8.6.02 – Mechanical emergency lowering



Never pull the red trigger handle upwards abruptly. To perform a controlled emergency lowering, pull on the red trigger handle as much as necessary but not as much as possible. You control the speed of lowering by how you pull on the red trigger handle.

8.7 Battery pack

There are two lead gel batteries in the removable battery pack. The batteries are maintenance-free and have to be recharged at regular intervals. There is no memory effect for the batteries. New, freshly charged batteries have a capacity of approx. 25 lifting/uprighting cycles under full load.



Do not charge the battery pack in wet areas. Choose a location that can be well ventilated, e.g. via a window. Never cover the battery pack during charging. At regular intervals, check that the circular ventilation opening on the rear of the battery pack is undamaged and intact.



Following transport/storage in cold environments, do not charge the battery pack until it has reached room temperature. Charge the battery pack at an ambient temperature from 5°C to 40°C.

If the battery capacity falls below a minimum value, a warning tone sounds. In this case, the battery pack needs to be charged immediately or replaced with a fully charged battery pack. A lifting/uprighting cycle that has already started may be continued to the end. Further operation in this condition results in a deep discharge and can result in damage to the battery pack.



A deep discharge damages the batteries so severely that they become unusable. Before initial commissioning of the product, and every time it is reassembled, the battery pack must be charged to ensure faultless operation and a long service life. For the charging time, see the chapter on Technical data, section **Electrical data**.

Removal and installation of the battery pack

The battery pack can be removed from the product without tools. This makes it possible to change the battery pack quickly. It also enables separate charging on a wall charging station, which is available as an accessory.

Removal

1. Press the emergency stop button (see chapter on Operation, section **Emergency stop button**).
2. Reach into the recessed grip on the battery pack from above and pull the unlocking lever up with your fingers (Fig. 8.7.01).
3. At the same time, tilt the battery pack slightly away from the mounting rail and then pull it upward out of the mounting (Fig. 8.7.01).

Insertion

1. Press the emergency stop button (see chapter on Operation, section **Emergency stop button**).
2. Reach into the recessed grip on the battery pack from above and pull the unlocking lever up with your fingers (Fig. 8.7.01).
3. Press the battery pack against the mounting rail and hold it while it slides down slowly onto the control unit. Ensure that the case guide encloses the mounting rail.

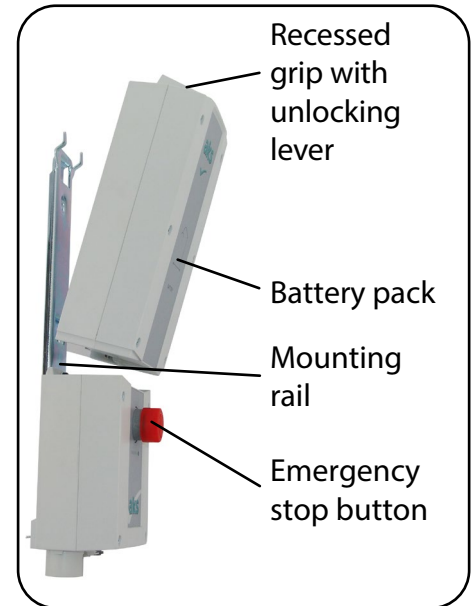

Fig. 8.7.01 - Battery pack



Ensure that the unlocking lever clicks audibly into place in the mounting rail and that the battery pack is firmly on the mounting rail. Fig. 8.7.02 shows the correct position and Fig. 8.7.03 shows an incorrect position.

4. Unlock the emergency stop button (see chapter on Operation, section **Emergency stop button**).

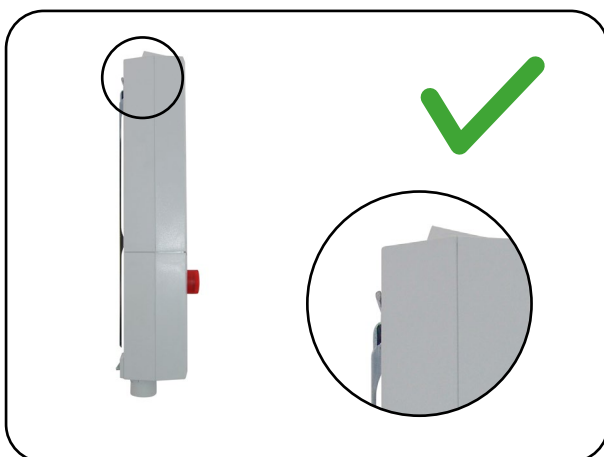

Fig. 8.7.02 - Battery pack mounted correctly on the mounting rail

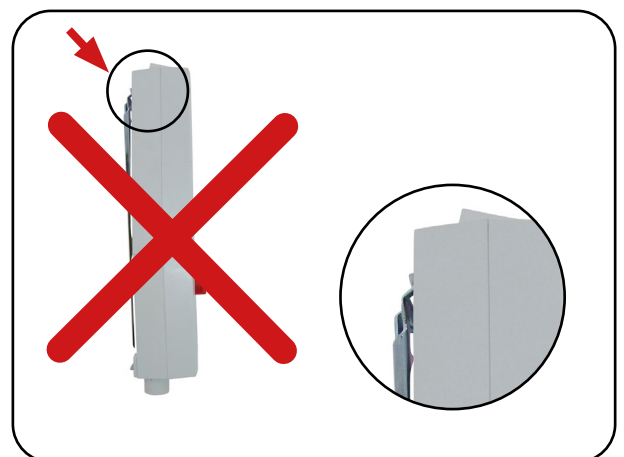

Fig. 8.7.03 - Battery pack mounted incorrectly on the mounting rail

Charging the battery pack

The battery pack can only be charged using the supplied charger (Fig. 8.7.05) directly on the control unit or using the wall charging station available as an accessory (see chapter on **Accessories/combinations**). The charging socket is located on the underside of the control unit (Fig. 8.7.04).

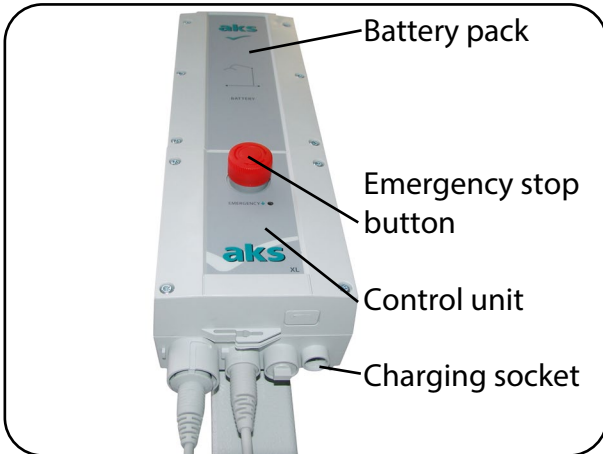

Fig. 8.7.04 – Control unit with charging socket

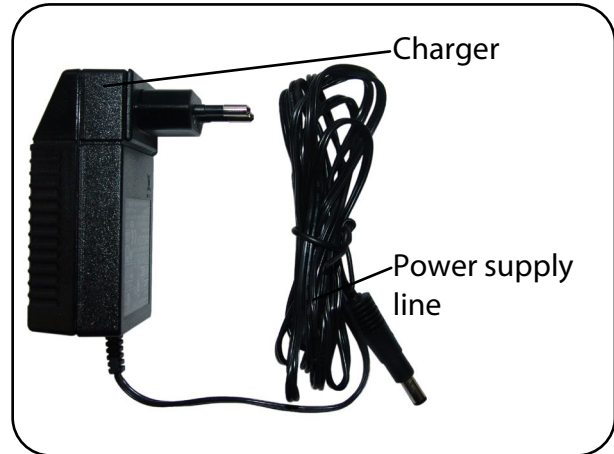

Fig. 8.7.05 – Charger with power supply line
(European plug attached to charger)



Do not use the product when the charger is connected to the mains supply! Improper handling can result in damage to the charger and in hazards such as electric shock. Never pull the charger’s power supply line and never drive over it. Do not touch the electrical contacts and do not short-circuit the contacts. Continued use of a damaged power supply line or charger can lead to hazards such as electric shock and to further hazards and malfunctions (short circuit). Damaged electrical components must be replaced immediately!



When charging the battery pack, make sure that the product is connected to the charger first. The charger should only be connected to the mains supply after the product has been connected.

Only plug the charger into the mains socket in the suspended position (Fig. 8.7.05). This prevents kinks from developing in the power line.

After charging, disconnect the charger from the mains supply first and then disconnect it from the product – failure to do so can result in damage to the device!

Charge the battery pack as often as possible to ensure an optimum service life.

Charge the battery pack at least once every 3 months to prevent damage due to self-discharge.

Replace the battery pack after 4 years at the latest. Depending on the intensity of use, it may be necessary to replace the battery pack sooner. Frequent and rapid discharge reduces the service life of the battery pack.

The battery pack must be replaced entirely in the event of a defect.



The plug type (e.g. UK plug instead of Euro plug) can be replaced simply by attaching a new plug.

Proceed as follows to charge the battery pack:

1. Actuate the emergency stop button (see chapter on Operation, section **Emergency stop button**). If you do not do this, there is a risk of the drives being activated during charging.
2. Insert the power supply line (Fig. 8.7.05) into the charging socket of the control unit (Fig. 8.7.04).
3. Plug the charger (Fig. 8.7.05) into a mains socket; connection specifications: see chapter on Technical data, section **Electrical data**.



Connect the charger directly to the mains supply. Only use mains sockets that have been installed properly and are suitable for use with the charger. Do not use a multiple socket. Ensure that the charger is always accessible so that the product can be disconnected from the mains supply in an emergency.

4. After the charging, first disconnect the charger from the mains socket and then disconnect the charger's power supply line from the control unit.

Indicator light on the charger (Fig. 8.7.06)

Yellow LED lights up – battery pack is charging

The yellow LED on the charger indicates that the charger is connected to the control unit correctly. If the yellow LED does not light up, there is no charging voltage present, i.e. the charger is defective or the connection is faulty.

Green LED lights up – battery pack is charged

The green LED indicates that charging is complete. Once the battery pack is fully charged, the LED lights up green, not yellow.

For the charging time, see the chapter on Technical data, section **Electrical data**.



Fig. 8.7.06 – Charger with power supply line

Accessories – charging the battery pack with the wall charging station

1. Remove the battery pack and place it on the wall charging station, as described in the previous section **Removal and installation of the battery pack**.
2. Check the power supply line of the wall charging station for damage. In case of damage, do not use the wall charging station. Mark the product clearly as “out of order” and inform your authorised dealer immediately.
3. Connect the wall charging station to the mains supply to start charging. Use only correctly installed mains socket suitable for the charger; connection specifications: see chapter on Technical data, section **Electrical data**.

The green LED (“ON”) indicates operational readiness and the yellow LED (“CHARGE”) indicates charging (Fig. 8.7.07). Once charging is complete, the yellow LED goes out and only the green LED is on, indicating operational readiness.

For the charging time, see the chapter on Technical data, section **Electrical data**.

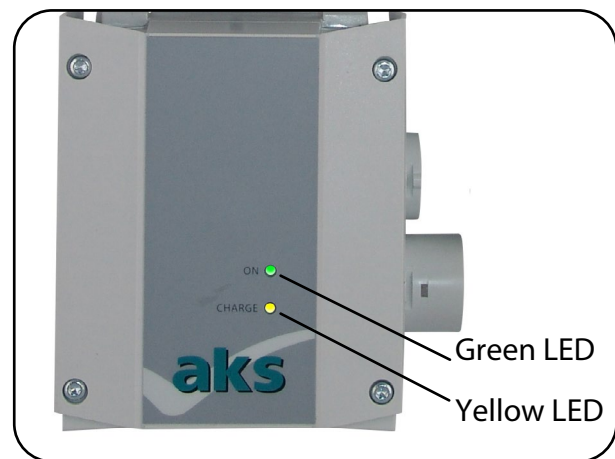

Fig. 8.7.07 – Wall charging station
(shown without cable hook)

8.8 Shutdown times

When not in use, the patient hoist / charging socket should be connected to the charger to ensure that the batteries are at full capacity for the next use (see chapter on Operation, section **Battery pack**). The integrated charging electronics prevent overcharging of the batteries and switch to trickle charging when the batteries are completely charged.



Press the emergency stop button to prevent accidental operation when the product is not in use (see chapter on Operation, section **Emergency stop button**).



If combined with the optional wall charging station, the removable battery pack can be removed during shutdown times and inserted in the wall charging station. This also guarantees that the batteries are at full capacity for the next use.

9 Patient transport



Observe the permissible maximum load (see chapter on technical data). Only load the combination, consisting of patient hoist, spreader bar/lifting arm and hoist sling, with the lowest permissible maximum load. This means that if there is a difference between the permissible maximum loads of the individual elements, the lowest permissible maximum load must be observed. If this instruction is not observed, safe operation can no longer be guaranteed. Furthermore, there is an increase to the risk that is always present when lifting/uprighting and transferring people.



In order to raise/upright a patient and transfer them with the product, the product must have been assembled properly as described in the chapter on **Assembly** and the information in the chapter on **Commissioning**. A suitable hoist sling is also needed for this application. The type and size of the hoist sling always depends on the stature of the patient and the type of use. aks GmbH provides a wide range of hoist slings (see chapter on **Accessories/combinations**) that are suited to the respective requirements.

9.1 Instructions for use

Before and during each use of the product, note the following information:



Always use the ergonomic grab handle to move the patient hoist. Never pull on the lift drive, spreader bar/lifting arm or on the patient.

Read the instructions for use of the hoist sling you are using in full before first use and before each subsequent use in order to avoid damage or dangerous situations due to misuse. The instructions contain important information and notes that are necessary for proper use of the product.

Before using the patient hoist, read the Accessories/combinations chapter to check that the combination of spreader bar/lifting arm and hoist sling is permissible.

Inspect the product (incl. accessories) before every use, especially the hoist sling (incl. accessories) after cleaning/disinfecting (see the chapter on Maintenance, section **Maintenance schedule: Inspection by the user**).

Do not use a damaged or heavily worn product/accessories. Failure to observe this requirement may cause the patient to fall, and thus result in severe or even fatal injury to the patient.



The product (incl. accessories) may only be used after careful consideration of the individual patient. The suitability of the product (incl. accessories) for the patient must be checked at regular intervals (e.g. in case of physical changes [amputation] or weight gain/loss). Consider the special requirements of the patient to ensure that **the right hoist sling in the right size, right type and right form is used for the patient in question**. Match the functional characteristics of the hoist sling to the specific disabilities and functional limitations of the respective patient. Potential contraindications must be observed in this regard.

Lifting/uprighting and transferring patients always involves a certain risk.

Before use, assess whether you need a second helper.

Before lowering or lifting the patient, make sure that the counterpart to the patient hoist, such as a bed or wheelchair, is braked.

Plan the operations in advance! Ensure that the planned repositioning and transfer does not involve any hazards. Take account of the floor conditions and the required working range (e.g. travelling width, turning radius, passage height of the patient hoist used, thresholds, obstacles).



Ensure that the sling loops do not catch in the castors of the hoist/wheelchair.

Before each lifting/uprighting process, check that all the loops on the spreader bar/lifting arm are suspended properly and not twisted when the hoist sling is pulled taut.

When using the product, make sure that the patient is in a stable and comfortable position in the hoist sling in order to prevent the patient falling out.

While moving the patient hoist, avoid fast and jerky movements that could result in the patient swinging.

Observe the patient during the entire transfer. Violent movements of the patient or holding on to objects during the transfer can result in hazards.

Arrange the patient transfer to be as short as possible and never leave the patient hanging unsupervised in the hoist sling or standing upright on the footboard.

Keep the product (incl. accessories) away from intense heat or open flame. The hoist slings are not flame-retardant. Make sure there is no smoking during use of the hoist sling. This applies to the user, the patient, and any other persons present during the use of the hoist sling.

Observe the specifications regarding cleaning/disinfecting (see the chapter on **Cleaning/disinfecting**). **Clean/disinfect the hoist sling (incl. accessories) according to the care instructions on the rating plate.** The table "Explanation of the care symbols" in the chapter **Product labelling** explains what these symbols mean. **Failure to observe the care instructions, for example by washing/drying at too high temperatures, will damage the hoist sling (seams), cause the patient to fall, and thus result in severe or even fatal injury to the patient.**

9.2 Lifting from a lying position

Using the aks standard sling (Fig. 9.2.01) as an example, these instructions for use describe how to attach a hoist sling and lift a patient from a lying position (for descriptions of other hoist slings and application cases, see the instructions for use for the hoist sling in question).

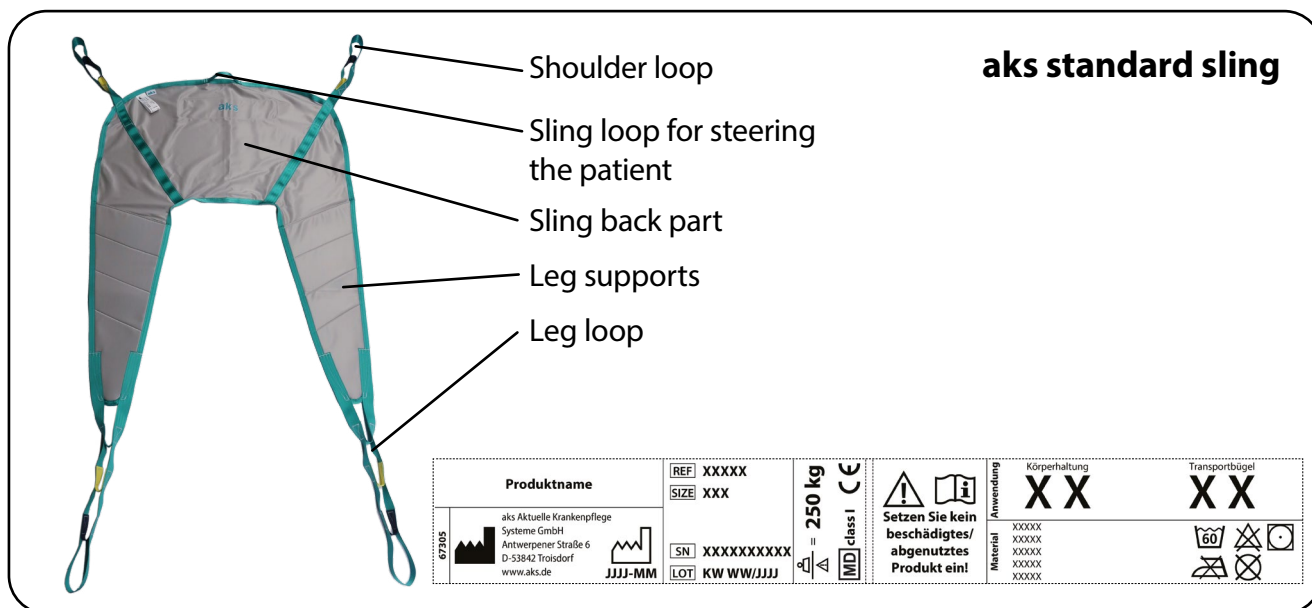

Fig. 9.2.01 – Outer side of aks standard sling



Only lift the patient as high as is necessary (i.e. until they are suspended) and lower them again before the transfer. Make the transfer as short as possible.

1. Talk to the patient and prepare them to be lifted by explaining the procedure. If necessary, reassure the patient.
2. Apply the brakes on the care bed and raise the side rail on the side opposite the user (does not apply to a conventional bed).
3. Move the reclining surface of the bed into a horizontal position.
4. Turn the patient onto his or her side if lying on his or her back. Support the patient to reduce the risk of falling.
5. Fold the hoist sling in half and lay it behind the patient's back. The lower edge should be at the height of the patient's coccyx (Fig. 9.2.02).
6. Turn the patient onto their other side. Support the patient again to reduce the risk of falling. Unfold the hoist sling and pull it flat on the reclining surface.
7. Now turn the patient back onto their back and arrange the leg supports between the patient's legs (Fig. 9.2.03). Make sure that the leg loops are the same length. The shoulder loops are now near the patient's right and left shoulders.
8. Slowly and carefully move the aks patient hoist towards the patient, taking care to avoid injuries caused by a collision. Pay attention to the spreader bar. Leave the aks patient hoist unbraked.
9. Cross the leg loops and attach them to the hooks on the spreader bar, as described in the Preparation chapter, section **Spreader bar of the aks patient hoists** (in the instructions for use for the hoist sling in question). Make sure that they are both in the same attached position. You can identify this by the colour coding on the loops (see Preparation chapter, section **Sling loops** - instructions for use for the hoist sling in question).

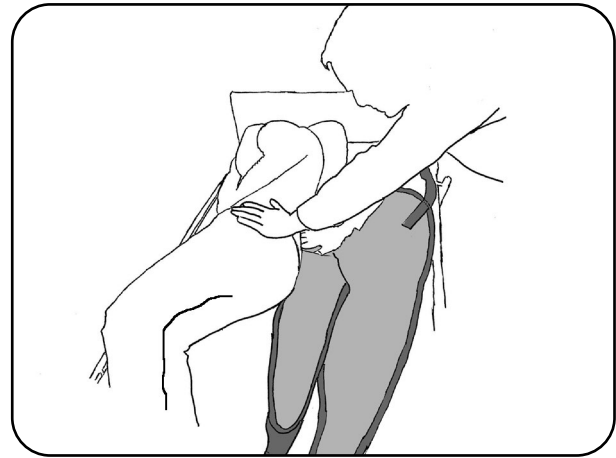

Fig. 9.2.02 - Hoist sling positioned behind the patient's back

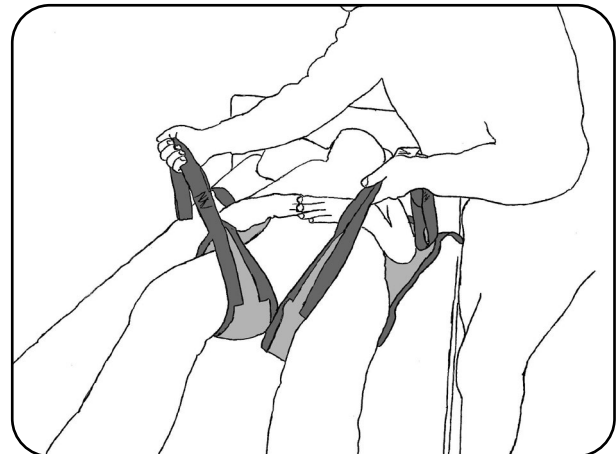

Fig. 9.2.03 - Leg supports positioned between the patient's legs



Crossing the leg loops provides maximum safety during transport and prevents the patient slipping out of the hoist sling; this applies in particular to patients who are paralyzed below the lumbar spin. In the case of patients who are sensitive to pressure pain, crossing the leg loops may result in discomfort in the genital region. If the patient is sufficiently stable and can actively take part in the lifting procedure, it is possible to attach the leg loops in parallel.



Always perform the first lifting procedure with crossed leg loops.

10. Attach the shoulder loops to the hooks on the spreader bar as described in the Preparation chapter, section **Spreader bar of the aks patient hoists** (in the instructions for use for the hoist sling in question). Ensure the attachment positions are identical here too, which you can identify by the colour coding on the loops (see Preparation chapter, section **Sling loops** - instructions for use for the hoist sling in question).
11. If possible, move the bed's backrest into an upright position.
12. Lift the patient with the aks-patient hoist (Fig. 9.2.04). While doing so, observe the patient and the tensioning of the hoist sling. If necessary, correct the position of the hoist sling by lowering the patient again and moving the parts of the hoist sling that are not positioned correctly. Observe the patient and the position of the hoist sling constantly throughout the entire lifting procedure. Only lift the patient as high as is necessary.
13. The patient can now be moved and/or transported. Make the lifting process or transfer as short as possible. Lower the patient prior to transfer.

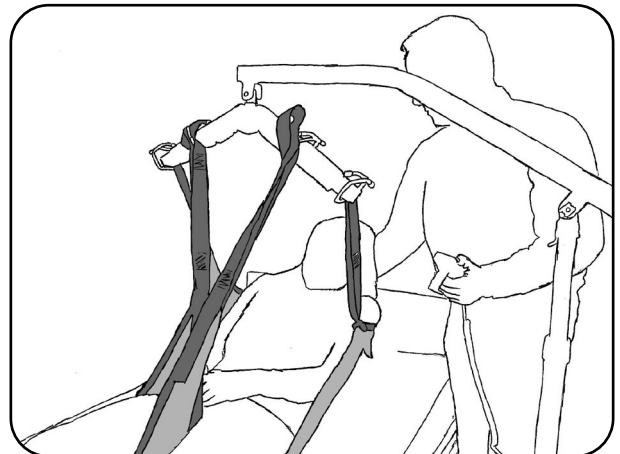

Fig. 9.2.04 - Lifting the patient

To lower the patient into a horizontal position after the lifting procedure/transfer, follow these instructions in reverse order. Please note that the instructions to be observed when lifting apply here too. The aks patient hoist remains unbraked even when setting down the patient.

10 Accessories/combinations



Only original aks accessory/spare parts may be used as accessories/spare parts, as only these have been tested by aks GmbH and thus guarantee faultless and safe function. Accessories/spare parts that have not been approved by aks GmbH can cause hazards. Never use drive components produced by other drive manufacturers (see the chapter on technical data, section **Electrical data**).

Accessories	REF
Wall charging station for battery pack (without battery pack)	89239
Wall charging station for battery pack (with battery pack)	89256
aks-efw 200 (digital scales set, incl. aks standard spreader bar and adapter for aks patient hoist, calibrated, for patients up to 200 kg)	89157



Further accessories/spare parts available on request.



Observe the permissible maximum load (see chapter on technical data). Only load the combination, consisting of patient hoist, spreader bar/lifting arm and hoist sling, with the lowest permissible maximum load.

Combinations that have not been approved by aks GmbH can cause hazards.

The following tables list the combinations that have been checked and approved by aks GmbH for safe use - of the aks patient hoists described in these instructions for use.

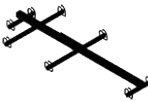
Combination with aks spreader bars	REF
Standard spreader bar 185 kg, light grey, including padding	 89253
Tandem spreader bar 185 kg, light grey, including padding	 89254
Horizontal transport spreader bar with 8-point attachment 185 kg, light grey	 89269

Combination with aks hoist slings
The approved aks hoist slings are listed on the following pages.

We reserve the right to make changes and amendments. As a result, the specifications for **REF** may vary. Latest **REF** available on request.

The following pictograms are used for the marking/assignment of hoist slings. Depending on the version, the hoist sling in question can be used for wet areas (fast-drying mesh material), for toilet visits (special processing/cut) or for patients with amputations (special processing/cut).



Hoist sling is suitable for **wet areas**



Hoist sling is suitable for **toilet visits**















Hoist sling is also suitable in case of **amputations**.

The following table summarises the combinations of aks hoist slings with the products described in these instructions for use that have been checked and approved by aks GmbH for safe use.

aks hoist slings								
Product	Application/ posture	Application/ posture		Standard spreader bar	Tandem spreader bar	Horizontal transport spreader bar (8-point attachment)	REF / SIZE	
Standard sling		✓	✗	✓	✓	✗	88700	S
							88701	M
							88702	L
							88703	XL
							88704	XXL
Standard sling with back reinforcement and integrated head support		✓	✗	✓	✓	✗	88705	S
							88706	M
							88707	L
Comfort sling with integrated head support		✓	✗	✓	✓	✗	88710	S
							88711	M
							88712	L
							88713	XL
							88714	XXL
Bath sling		✓	✗	✓	✓	✗	88715	S
							88716	M
							88717	L
							88718	XL
							88719	XXL
Bath sling with back reinforcement and integrated head support		✓	✗	✓	✓	✗	88720	S
							88721	M
							88722	L
Comfort bath sling with integrated head support		✓	✗	✓	✓	✗	88725	S
							88726	M
							88727	L
							88728	XL
							88729	XXL
Bath sling with Flex head support		✓	✗	✓	✓	✗	88791	S
							88792	M
							88793	L
							88794	XL
							88795	XXL
Hygienic sling		✓	✗	✓	✓	✗	88730	S
							88731	M
							88732	L
							88733	XL
							88734	XXL

See next page for more hoist slings.

aks hoist slings								
Product		Application/posture		Standard spreader bar	Tandem spreader bar	Horizontal transport spreader bar (8-point attachment)	REF / SIZE	
								
Comfort hygiene sling		✓	✗	✓	✓	✗	88735	S
							88736	M
							88737	L
							88738	XL
							88739	XXL
Hygiene sling with back reinforcement		✓	✗	✓	✓	✗	88786	S
							88787	M
							88788	L
							88789	XL
							88790	XXL
Fast transport sling with breast loop		✓	✗	✓	✓	✗	88740	S
							88741	M
							88742	L
Fast transport sling with breast loop for bathing		✓	✗	✓	✓	✗	88771	S
							88772	M
							88773	L
Horizontal transport sling		✓	✓	✗	✓	✗	88746	M
							88747	L
							88748	XL
							88749	XXL
Horizontal transport sling with 8-point attachment		✗	✓	✗	✗	✓	88751	M
							88752	L
							88753	XL
							88754	XXL
Horizontal transport sling with 8-point attachment for bathing		✗	✓	✗	✗	✓	88777	M
							88778	L
							88779	XL
							88780	XXL
Universal comfort sling		✓	✓	✓	✓	✗	88756	M
							88757	L
							88758	XL
							88759	XXL
Universal mesh sling	 	✓	✓	✓	✓	✗	88760	S
							88761	M
							88762	L
							88763	XL
							88764	XXL
Universal Flex sling	 	✓	✓	✓	✓	✗	88766	S
							88767	M
							88768	L
							88769	XL
							88770	XXL
Standard sling (2 single slings)		✓	✗	✓	✗	✗	88765	M

Accessories* for aks hoist slings		
Product	REF	SIZE
aks extension loops (set comprising 2 pieces)	88796	24 cm
aks head support	88798	M

*can be combined as per instructions for use

We reserve the right to make changes and amendments. As a result, the specifications for **REF** may vary. Latest **REF** available on request.

Compatibility



Our hoist slings for lifting hoists can be used with all aks hoists and with a number of hoists from other manufacturers. Please note our declaration of compatibility for hoist slings. This can be found on our website: www.aks.de



If hoist slings from another manufacturer are used, the combination must be approved. The other manufacturer must confirm compatibility with the aks patient hoist. Without this confirmation/approval, the risk to the life and health of all persons involved that is always present when lifting/uprighting and transferring people may be increased.

11 Troubleshooting

Not all malfunctions are caused by product faults. The following table provides assistance for troubleshooting. If you are unable to rectify the malfunction using the information in this table, please contact your authorised dealer.



Repairs to and measurements of the electrical components may only be performed by suitably qualified personnel (see chapter on **Maintenance**). **Other persons** (e.g. users) **are not under any circumstances permitted to attempt to resolve defects by themselves.**

Malfunction	Possible causes	Remedy
aks patient hoist does not lift/ aks patient hoist does not spread	Emergency stop button pressed	Unlock emergency stop button
	Manual control unit plug not plugged in or not plugged in correctly	Plug in manual control unit
	Patient hoist connected to charger	Wait until charging is complete; then disconnect the charger from the patient hoist
	Battery pack not yet mounted/still on wall charging station	Place the charged battery pack onto the control unit
	Battery pack discharged	Charge battery pack
	Battery pack defective	Replace battery pack
	Batteries defective/deeply discharged	Replace batteries Contact authorised dealer
	Lift drive/spreader drive, plug not plugged in or not plugged in correctly	Insert plug
	End position reached	Move the lift drive in the opposite direction
	Lift drive/spreader drive defective	Replace lift drive/spreader drive Contact authorised dealer
	Maximum load exceeded	Reduce load (If the lifting/uprighting procedure has already commenced, lowering is possible by actuating the manual control unit several times.)
The lifting/uprighting process stops during operation		
A warning signal sounds when the manual control unit is actuated	Battery pack is discharged as far as the warning threshold	Charge battery pack
Battery pack is not charging (yellow LED on the charger does not light up)	No correct connection between power supply line and control unit	Check plug connections
	Power supply line or charger defective	Replace charger Contact authorised dealer



The sounding of a warning tone indicates that the battery capacity is too low (see chapter on Operation, section **Battery pack**).

Wall charging station accessories

Malfunction	Possible causes	Remedy
Battery pack is not charging (flash ready indicator does not light up)	Wall charging station not connected to mains supply	Check plug connections
	Power supply line defective	Replace power supply line Contact authorised dealer
	Wall charging station defective	Replace wall charging station Contact authorised dealer

12 Cleaning/disinfecting

Cleaning: Achieving a state of cleanliness (visible). Removal of contamination to the extent required for the intended purpose of the product.

Disinfection: Reducing the number of or destroying microorganisms (not visible). Procedure designed to reduce the number of viable micro-organisms to a pre-defined acceptable level appropriate to the intended purpose of the product.



When cleaning/disinfecting the product, note that the individual components could be infectious or contaminated. Take suitable precautions for your own safety. Use suitable packaging/labelling to ensure that the product/accessories can be transported without any risk to third parties.



Note the difference between cleaning/disinfecting for use by “**the same patient**” and cleaning/disinfecting for “**reuse**”. Note that, for reuse in particular, only disinfection methods that are performed according to a validated procedure¹ with the suitable process parameters are permitted.

The lift drive and, if applicable, the spreader drive must be retracted before cleaning and disinfection. In other words, the lifting arm is in the lowest position and the chassis is closed.



The product must always be disconnected from the mains supply for cleaning and disinfection in order to prevent risk of electric shock and functional failure (short circuit). The plugs and sockets on the product are only protected against spray water when plugged together.

Press the emergency stop button before cleaning and disinfection.

Note that protection against spray water is only guaranteed (protection type/moisture protection) when the battery pack is attached.

The product’s electrical components are protected against spray water to IPX4 as a minimum (see chapter on Technical data, section **Electrical data**). Note that if there is a difference between the protection types of different components, the lowest protection type must be taken into account. Failure to comply means that safe operation can no longer be guaranteed.

The electrical components must show no external signs of damage. In case of damage, water and cleaning agents may get into the electrical components. This can cause malfunctions and damage to the electrical components. Do not use the components if they become damaged. Mark the product clearly as “out of order” and inform your authorised dealer immediately.

Before putting the product back into use, make sure that there is no residual moisture on the electrical contacts. This can be done by wiping or blowing the contacts dry. If water or cleaning agent has got into the components, do not use them. Mark the product clearly as “out of order” and inform your authorised dealer immediately.

¹ E.g. in accordance with the requirements of the Robert Koch Institute (RKI) or another procedure that has been validated by the operator/treatment personnel.



Never clean the product, particularly the electrical system, with a high pressure cleaner, water hose or in a continuous batch washing system because the surfaces and seals can be damaged and/or water can penetrate. Never submerge the product in liquid. Do not subject the product to mechanised cleaning/disinfection.

Failure to observe the safety instructions can result in significant damage to the product, and may have further aftereffects.

12.1 General cleaning and disinfecting instructions

The product is suitable for reuse (see the chapter on **Reuse**). The product is manufactured subject to the highest quality standards. The following manufacturer information on cleaning/disinfecting must always be observed to ensure that the characteristics stated by the manufacturer do not change. This is the only way to guarantee that the product is safe and effective for its intended purpose.

Both domestic and professional cleaning agents and disinfectants can be used to clean and disinfect the product. The following points must be observed:

Never use

- Abrasive agents or cleaning materials containing ammonium chloride
- Basic/alkaline cleaning agents
- Aggressive cleaning materials, e.g. solvents and hard brushes etc.
- Oil-based furniture polishes for the electrical components

If possible, use

- Environmentally and dermatologically tested cleaning agents
- Alcohol-free and chlorine-free disinfectants and methods for wipe disinfection from the Robert-Koch Institut (RKI) list or the disinfectants list of the Verbund für Angewandte Hygiene e.V. (VAH)

Observe the instructions and safety precautions from the manufacturers of the cleaning and disinfectant materials.



Clean and disinfect the product at regular intervals and whenever there is evident soiling, and keep a proper log of the cleaning/disinfection.

Note that the surfaces of the product must be undamaged when cleaning/disinfecting them, otherwise moisture can get into the product. In case of damage (e.g. scratches/dents that go all the way through the varnish), contact your authorised dealer immediately.



In addition to regular maintenance, regular cleaning helps to identify loose and/or worn parts. This ensures trouble-free operation and extends the product's service life.

Disinfection of the castors is only required if they are visibly contaminated with infectious/potentially infectious material.

Wear gloves during cleaning/disinfection to prevent the cleaning agents/disinfectants from coming into direct contact with your skin.

Keep the surface disinfectants you use in sealed containers and note that these will need replacing at regular intervals in accordance with the manufacturer's specifications. We recommend using re-sealable pump dispensers to apply cleaning agents/disinfectants to cleaning cloths.

Make sure the room is ventilated sufficiently, or air it out thoroughly after disinfecting the surfaces of the product.

12.2 Cleaning by the user/operator

The product can be cleaned by hand with a damp cloth and a mild, alcohol-free cleaning agent.

12.3 Disinfection by the user/operator

Please note: it is important to clean the product thoroughly prior to disinfection! To disinfect the product by hand, perform wipe disinfection. For regular disinfection by the user, domestic disinfectants can be used. Validated disinfectants² must always be used when carrying out treatment for reuse.

If you have further questions regarding disinfection, please contact your authorised dealer.

12.4 Approved disinfectants and disinfection methods



When using disinfectants and disinfection methods, always observe the corresponding information from the manufacturer, particularly the specifications regarding concentration (dosage) and exposure time. Always use cold water (max. 30°C) when diluting disinfectants.

The following disinfectants and disinfection methods have been tested and approved by aks GmbH.

Wipe disinfection

Manufacturer of disinfectant	Designation / active ingredient	Effectiveness* (degree of disinfection)
Ecolab	Incidin™ Rapid ³	A

* A: Suitable for killing vegetative bacteria, including mycobacteria and fungi including fungal spores

2 E.g. in accordance with the requirements of the Robert Koch Institute (RKI) the Verbund für Angewandte Hygiene e. V. or another disinfectant that has been validated by the operator/treatment personnel.

3 According to the Verbund für Angewandte Hygiene e.V. (VAH) Active ingredient basis: Aldehyde(s), quaternary compound(s)

13 Storage

The storage location should be as cool and dry as possible and not exceed normal room temperature. The climatic conditions are described in the chapter on **Technical data** and must be complied with.



Ensure damage and continual strain are ruled out during the storage period.

Do not place anything on the product that could damage it (e.g. pointed objects with sharp edges).



For long-term storage, the product should be stored in a clean and dry state. Use the original packaging for storage to protect the product against dust and/or cover the product with foil or a sheet.

Keep the product away from direct sunlight, fire and heat sources (e.g. heating, stoves etc.).

Before placing the product in storage for longer periods, charge the battery pack fully. Before placing the product in storage for longer periods, activate the emergency stop button (see chapter on Operation, section **Emergency stop button**).

In the event of storage for longer periods, make sure that the batteries in the battery pack are fully charged at least once every 3 months to prevent damage due to self-discharge.



A deep discharge results in destruction of the batteries.

13.1 Shutdown

If the product is no longer to be used and is to be removed from service, proceed as follows:

1. Brake the two rear castors on the operator side by activating the foot lever (Fig. 13.2.03) (see chapter on Operation, section **Castors**).
2. Move the lifting arm to its lowest position (see chapter on Operation, section **Manual control unit**).
3. Press the emergency stop button (see chapter on Operation, section **Emergency stop button**).

13.2 Folding away

The product can be folded up after shutdown for transport purposes or space-saving storage.

1. Remove accessories from the lifting arm (e.g. spreader bar, scales, etc.); see chapter on Assembly, section **Assembly of the patient hoist**.
2. Remove the locking plate and the pin that fastens the lift drive to the lifting arm's retaining plate (Fig. 13.2.01). Swivel the lift drive forwards and mount the pin with the locking plate on the retaining plate.
3. First swivel the lift drive and then swivel the lifting arm to the stand mast. You have to push the lift drive to one side to make space for the lifting arm. Otherwise, there is a risk of damaging the drive pipe (Fig. 13.2.02).

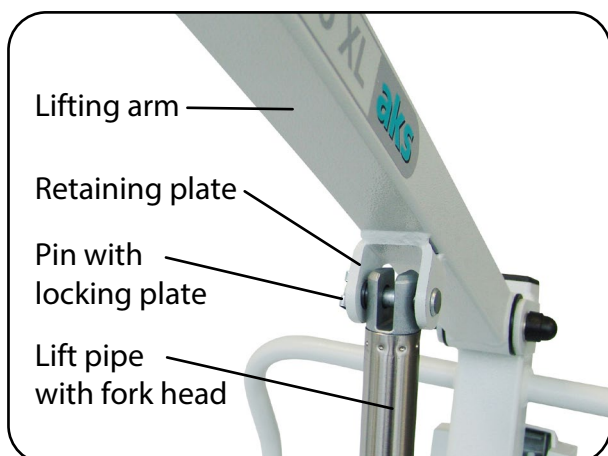

Fig. 13.2.01 – Retaining plate on lifting arm

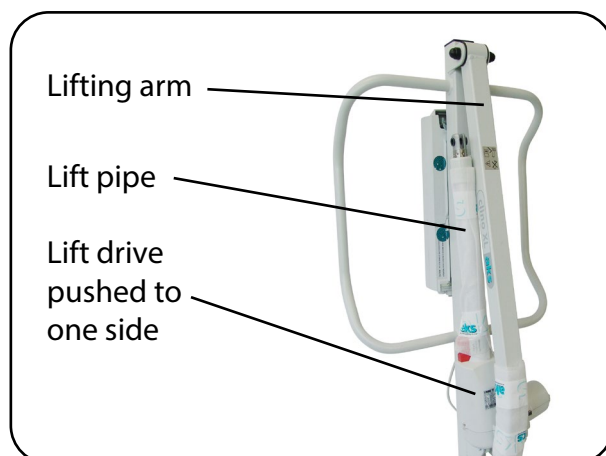

Fig. 13.2.02 – Lift drive and lifting arm

4. Fix the lift drive and lifting arm to the stand mast using cable ties or Velcro strip. If stored for longer periods of time, the lift drive and lifting arm should be wrapped in their original packaging (Fig. 13.2.03) (see chapter on **Storage**).

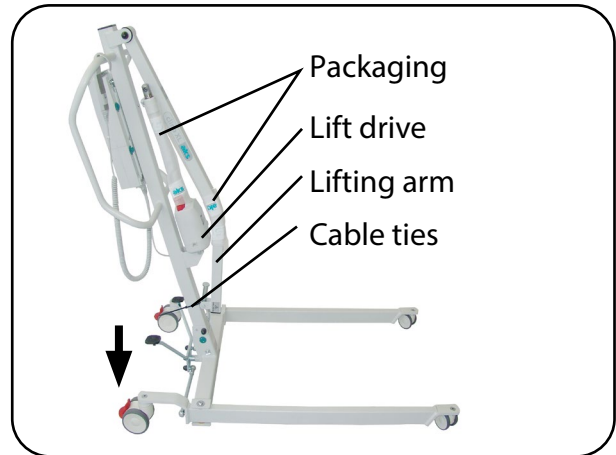

Fig. 13.2.03 – Stand mast set upright rear castors braked

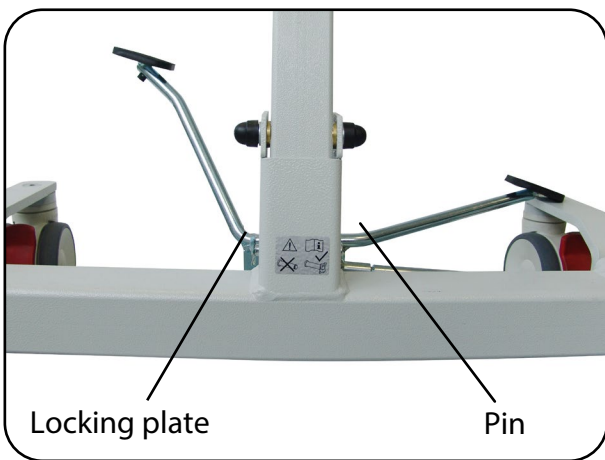

Fig. 13.2.04 – Stand mast holder



Fig. 13.2.05 – Folding away the stand mast

5. Remove the pin with the locking plate from the stand mast holder (Fig. 13.2.04) and slowly and carefully fold the stand mast forwards (Fig. 13.2.05).
6. Lock the stand mast in place with the pin on the stand mast holder. Secure the pin with the locking plate (Fig. 13.2.06).

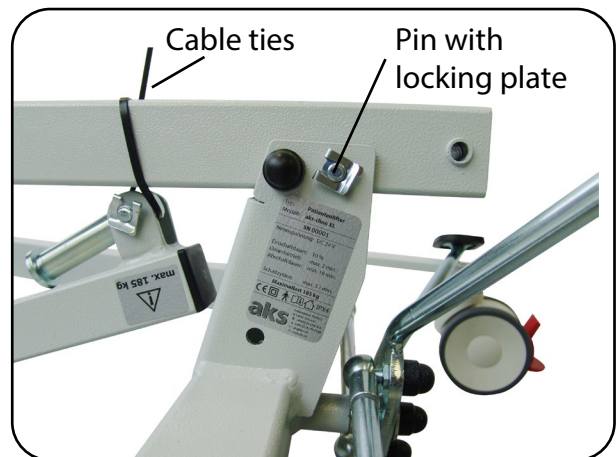

Fig. 13.2.06 – Stand mast holder

14 Reuse

The products described in the instructions for use are suitable for reuse. Before reusing the product in question (e.g. in the event of a change of patient), make sure that it has been cleaned and disinfected as described in the chapter on **Cleaning/disinfecting** and serviced as described in the chapter on **Maintenance**, and that any defects or damage found has been repaired by the appropriate qualified personnel and/or the components in question replaced.



Observe the safety instructions (see chapter on **Safety instructions**).

15 Service life

If the product is used as intended, cleaned and disinfected as described in the chapter on **Cleaning/disinfecting** and maintenance work is carried out at regular intervals as defined in the maintenance schedule (see chapter on **Maintenance**), the following service lives/useful lives are possible:

Component	Service life/useful life
Patient hoist	approx. four years
Hoist sling	approx. two years

If the products are treated properly and handled carefully, cleaned/disinfected as described in the chapter on **Cleaning/disinfecting**, and maintained regularly in accordance with the maintenance schedule (see chapter on **Maintenance**), they can also be used for longer. In case of domestic use, for example, the following service lives/useful lives are possible, which are not possible in case of use in inpatient facilities:

Component	Service life/useful life
Patient hoist	up to eight years
Hoist sling	up to four years



Do not use a damaged or heavily worn product. Failure to observe this requirement may cause the patient to fall, and thus result in severe or even fatal injury to the patient.



Note the lowest maximum permissible load in each case! Exceeding the maximum permissible load (see chapter **Technical data**) not only reduces the service life/useful life of the product, it also increases the risk that is always present when lifting/uprighting and transferring patients.

Observe the permissible maximum on-time of the drives. Exceeding the permissible maximum on-time (see chapter on technical data, section **Electrical data**) also reduces the service life/useful life of the product.

Replace the battery pack after 4 years at the latest. Depending on the intensity of use, it may be necessary to replace the battery pack sooner. Frequent and rapid discharge reduces the service life/useful life of the battery pack.



The product's service life/useful life is of course dependent on how it is used (usage conditions/frequency of use). Frequent adjustment, transportation, set-up, cleaning and disinfection reduce the service life/useful life, as do improper handling, improper storage and irregular maintenance.

The fact that aks GmbH specifies an expected service life/useful life for the products does not represent an additional guarantee.

The product has been tested successfully with 11,000 lifts for endurance functionality according to EN ISO 10535. For a service life/useful life of approx. eight years, that means up to four lifting processes per day.

16 Disposal

The products described in these instructions for use are made of metal and plastic parts along with electrical components. These must be disposed of properly, separately and in accordance with the statutory requirements.

Sort the packaging materials according to the parts that are recyclable, and recycle these in accordance with the applicable environmental regulations. Properly dispose of the parts that are not recyclable in your country.



When disposing of the product, note that the individual components could be infectious or contaminated. Take suitable precautions for your own safety. Use suitable packaging/labelling to ensure that the product/accessories can be disposed of without any risk to third parties.

Contact your local disposal company. For disposal in countries other than Germany, observe the respective applicable national laws, regulations and provisions.

The product is compliant with Regulation (EU) 2020/171, known as the REACH Regulation of the European Parliament and of the Council from 6 February, 2020 concerning the Registration, Evaluation, Authorisation and Restriction of Chemicals.

This product is classed as an item of electrical and electronic equipment intended for professional use (b2b) in accordance with the WEEE Directive 2012/19/EU (Waste Electrical and Electronic Equipment). The electrical components must be treated as waste electrical equipment in accordance with the WEEE Directive and disposed of properly. This is indicated by the symbol in Fig. 16.01.

The product complies with EU Directive 2011/65/EU (RoHS II) of the European Parliament and Council dated 8 June 2011 for the restriction of the use of certain hazardous substances in electrical and electronic equipment.

In the case of electrical equipment brought into circulation after 13 August 2005, the owner is legally obligated not to hand over electrical components to municipal collecting points but to send them directly to the manufacturer. The general terms and conditions of aks GmbH apply to these returns.

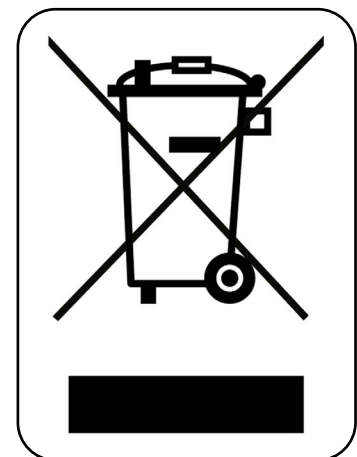

Fig. 16.01 – WEEE marking

Notice pursuant to the German Batteries Act (BattG)

The batteries contained in this product are subject to the Batteries Act (BattG). Old batteries must not be disposed of in domestic waste. This is indicated by the symbol in Fig. 16.02. The additional "Pb" marking in the symbol indicates that the battery contains lead (Pb).

The end user is legally obligated to return old batteries. They can be submitted free-of-charge to a municipal collection point or returned to the manufacturer for proper disposal. The general terms and conditions of aks GmbH apply to these returns.

Batteries can contain hazardous substances that may harm the environment or human health if they are stored or disposed of improperly. Batteries contain valuable resources which can be reused through separate collection.

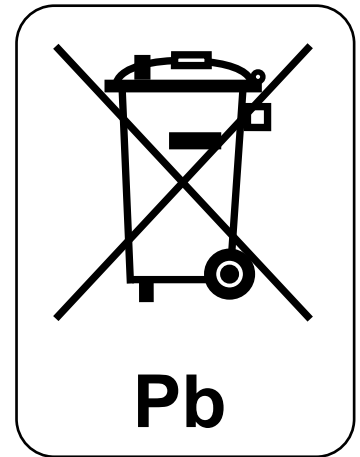

Fig. 16.02 – BattG marking



Make sure that the poles of batteries are insulated when disposing of them or sending them for disposal.

17 Warranty

The products described in these instructions for use are distinguished by their long service life and high reliability. Should a fault occur and the product cease to operate correctly, check the malfunction using the table in the chapter on **Troubleshooting**. If the fault cannot be cleared in this way, contact your authorised dealer, who will provide a remedy as quickly as possible and procure the required spare parts.

We guarantee the faultless condition of our products in accordance with our sales and delivery conditions. In respect of material defects, we provide a manufacturer's warranty for **24 months** from the date of purchase (soiling and normal wear are not covered by the warranty).



Non-observance of the instructions for use, improper use, improperly carried out maintenance work, and technical modifications and additions (e.g. attachments) without the permission of aks GmbH render the warranty and general product liability void.

Before using the product on parquet/natural wood floors, check whether the floor sealant is suitable for preventing the castors from causing damage (e.g. discolouration). Aks GmbH accepts no liability for damage arising from everyday use on floors (see chapter on operation, section **Castors**).

We reserve the right to make technical changes for the purpose of improvement. For the product designation and information for clear identification (e.g. **SN**, **LOT**), refer to the rating plate (see chapter on **Product labelling**).

18 Declaration of conformity

The products described in these instructions for use comply with all the applicable requirements of Regulation (EU) 2017/745 on Medical Devices (MDR). During the development, the applicable parts of the following standards were taken into account:

- EN ISO 10535 Hoists for the transfer of disabled persons - Requirements and test methods
- EN 60601-1 Medical electrical equipment - Part 1: General requirements for basic safety and essential performance
- EN 60601-1-2 Medical electrical equipment - Part 1-2: General requirements for basic safety and essential performance – Collateral standard: Electromagnetic disturbances - Requirements and tests
- EN 12182 Assistive products for persons with disability - General requirements and test methods

The full Declaration of Conformity is available on request.

19 Maintenance

19.1 General maintenance instructions

The service life of the products (incl. accessories) described in these instructions for use is of course dependent on the type of use.



In order to ensure safe operation, the product in question must be visually inspected and functionally checked at regular intervals by appropriate qualified personnel, at least once a year, every time the product is returned to use and after every repair, in accordance with the maintenance schedule. Shorter inspection cycles may be necessary if the product is used more frequently than normal.

EN ISO 10535 specifies the following in Annex B:

“Periodic inspection should be performed by a suitable and properly qualified person who is familiar with the design, application and maintenance of the hoist.”

If the product is not regularly and properly serviced, safe use is no longer guaranteed. Wear, damage as well as loosening of connecting elements can therefore not be detected.



If any checks indicate defects/damage, immediately disconnect the product from the mains supply and do not operate it again. Press the emergency stop button and remove the battery pack (see chapter on Operation, section **Emergency stop button** and section **Battery pack**). Mark the product clearly as “out of order” and inform your authorised dealer immediately.



Unplug the product from the mains supply and press the emergency stop button before the visual inspection to prevent danger, e.g. from damaged insulation on power supply lines. If you do not identify any damage during your visual inspection, unlock the emergency stop button for the function test.

Regularly and at short intervals check the power supply line for mechanical damage (e.g. monthly and after any mechanical strains that occur).

Defective/damaged electrical components must be replaced by suitable qualified personnel. Electrical components must not be opened and must be replaced as complete units.

Exception: Replacement of the batteries (battery pack) by suitable trained and qualified personnel.

Removed, defective/damaged electrical components may only be checked and evaluated by a qualified electrician or aks GmbH.



Do not carry out any repairs on the product that would alter the product characteristics. If this instruction is not observed, a safe power supply can no longer be guaranteed. Furthermore, there is an increase to the risk that is always present when lifting/uprighting and transferring people. In addition, any warranty claims and product liability are excluded.

Maintenance may only be carried out on empty patient hoists.



Only original aks spare parts and aks accessory parts that are approved for this product may be used (see chapter on **Accessories/combinations**). Otherwise, any warranty claims and product liability are excluded. You must not make any technical modifications and additions without permission from aks GmbH.

In Germany, the EU Medical Devices Adaptation Act (MPEUAnpG) applies, including the Medical Devices Implementation Act (MPDG) and the Medical Devices Operator Ordinance (MPBetreibV). The corresponding national laws, regulations and requirements are applicable in other countries.

The latest versions of EN 62353 and the maintenance schedule must be used as test specifications for the products (incl. accessories) described in these instructions for use, and this must be properly documented.

Perform all tests under normal indoor ambient conditions (humidity and temperature). Perform the tests in the specified order (visual inspection first, then operating load test). Perform all the tests on the same product and document your results. The following information must be provided as a bare minimum:

- Name and address of testing company
- Name of tester
- Test date
- Information on the product, incl.: Type, size, date of manufacture/production, serial number, catalogue number where applicable
- permitted maximum load
- Name and address of the manufacturer
- Test results
- Indication of next test date



Also read and observe the instructions for use for the accessories.

19.2 Maintenance schedule: Inspection by the operator

Perform maintenance of the product (incl. accessories) at least once a year, before every reuse, and after every repair.



Article 7 of the MPBetreibV specifies the following:

*“Maintenance measures refer to inspections and **maintenance tasks** that are necessary in order to continuously ensure safe and proper operation of medical devices. The maintenance measures shall be performed taking the **manufacturer’s instructions** into consideration (...).”*

EN ISO 10535 specifies the following in Annex B:

*“The definition of the periodic inspections and maintenance distinguish between inspection and maintenance. The periodic inspection and, where necessary, maintenance of the hoist [...] must be carried out in accordance with the manufacturer’s instructions. In general, an **annual inspection¹ of the critical parts²** is advisable.”*

“After maintenance or inspection of the hoist, the result (approved/not approved) must be clearly stated on the device.”

Application area	
<input type="checkbox"/> Private household	<input type="checkbox"/> In-patient facility <input type="checkbox"/> _____
Client: _____	First time use (YYYY/MM) _____/____
Last inspected on: _____	by: _____
Inspection prior to initial commissioning conducted on: _____	by: _____
Data for the aks patient hoist	
Date of manufacture (YYYY/MM) _____/____	SN _____
Inventory number: _____	

UDI-DI aks patient hoist			
Version with locking plate			
<input type="checkbox"/> foldy [®]	04251818703089	<input type="checkbox"/> foldy [®] e	04251818703102
<input type="checkbox"/> foldy [®] mini	04251818703126	<input type="checkbox"/> foldy [®] e mini	04251818703140
<input type="checkbox"/> foldy [®] micro	04251818703171		
<input type="checkbox"/> foldy [®] XL	04251818703195	<input type="checkbox"/> foldy [®] e XL	04251818703218
<input type="checkbox"/> clino [®] II	04251818703294		
<input type="checkbox"/> clino [®] XL	04251818703300	<input type="checkbox"/> clino [®] e XL	04251818703324
<input type="checkbox"/> goliath [®]	04251818703348		
UDI-DI aks patient hoist			
Version with tube clip			
<input type="checkbox"/> foldy [®]	04251818703096	<input type="checkbox"/> foldy [®] e	04251818703119
<input type="checkbox"/> foldy [®] mini	04251818703133	<input type="checkbox"/> foldy [®] e mini	04251818703157
<input type="checkbox"/> foldy [®] XL	04251818703201		
<input type="checkbox"/> clino [®] XL	04251818703317	<input type="checkbox"/> clino [®] e XL	04251818703331

- Article 11 of the MPBetreibV specifies the following for technical safety inspections for the medical devices specified in Annex 1 of the MPBetreibV:
“The owner shall schedule inspection intervals accordingly to ensure that the defects that are to be expected on the basis of past experience can be identified in good time.”
Technical safety inspections do not apply to the products described in these instructions for use. The wording specifies the owner’s responsibility.
- The critical parts include, among other items, the hoist’s load-bearing structure and the lifting mechanism, with the fasteners, brakes, controls, safety equipment and body-support systems.

The following maintenance schedule provides help for this inspection:

Item	Inspection of the aks patient hoist – check points*	OK	NOK	n/a
1	Check of the basic requirements			
1.1	Appropriate and safe use (no collision points for the lifting/uprighting function and during transfer)			
1.2	Permissible accessories or device combination			
1.3	Rating plates, stickers for the date of manufacture and maximum load, warnings for the locking plate/tube clip and product stickers present and legible (see chapter on Product labelling)			
1.4	Instructions for use available, legible and accessible to user			
2	Visual inspection of the mechanical parts - The patient hoist must be disconnected from the charger (see chapter on Operation, section Battery pack) - The emergency stop button must be pressed (see chapter on Operation, section Emergency stop button)			
2.1	No unauthorised interventions, modifications or improper handling			
2.2	No soiling (particularly on the lift pipes of the drives)			
2.3	No surface damage (e.g. paint damage) or corrosion			
2.4	No deformation or sheared weld seams			
2.5	No mechanical wear (particularly on the lift pipes of the drives)			
2.6	Connection elements: Screws in place and tightened			
2.7	Connection elements: Pin with locking plate in place and correctly mounted (see chapter on Assembly)			
2.8	Connection elements: Pin with linchpin in place and correctly mounted (see chapter on Assembly)			
2.9	Connection elements: Tube clip in place and correctly mounted (see chapter on Assembly)			
2.10	Connection elements: Star handle in place and correctly mounted/tightened (see chapter on Assembly)			
2.11	Connection elements: Clamping lever in place and correctly mounted/tightened (see chapter on Assembly)			
2.12	Connection elements: Replace pin with locking plate if there are signs of wear, e.g. inclusions (see chapter on Assembly)			
2.13	Connection elements: Replace pin with linchpin if there are signs of wear, e.g. inclusions (see chapter on Assembly)			
2.14	Connection elements: Replace tube clip if there are signs of wear, e.g. inclusions (see chapter on Assembly)			
2.15	Connection elements: Replace star handle if there are signs of wear, e.g. inclusions (see chapter on Assembly)			
2.16	Connection elements: Replace clamping lever if there are signs of wear, e.g. inclusions (see chapter on Assembly)			
2.17	Caps and dummy plugs present and undamaged			
2.18	Castors: undamaged and fastened			
2.19	Spreading mechanism: undamaged and fastened			

Maintenance schedule continues on next page.

(*)

OK	in order	The condition or the function complies with the requirements
NOK	not in order	The condition or the function does not comply with the requirements. The defect has to be rectified by a repair or replacement
n/a	not applicable	Property/component/function not present

Item	../Visual inspection of the mechanical parts	OK	NOK	n/a
2.20	Spreader mechanism, mechanical spreading: both rubber caps present on the foot pedal (see chapter on Operation, section Spreading)			
2.21	Retaining bolt with collar (fixes the spreader bar) Collar height must be at least 4 mm (see Fig. 21.01), must be replaced if there are signs of wear (e.g. inclusions) – the bar padding must be open for this inspection (see chapter on Assembly)			
2.22	Sliding washer is present on the retaining bolt with collar and is undamaged (no wear, thickness at least 1 mm (see Fig. 21.01)) (see chapter on Assembly)			
3	Visual inspection of the electrical parts - The battery pack must be mounted (see chapter on Operation, section Battery pack) - The patient hoist must be disconnected from the charger (see chapter on Operation, section Battery pack) - The emergency stop button must be pressed (see chapter on Operation, section Emergency stop button)			
3.1	Product-specific drive components present, all systems from a single manufacturer (see chapter on Technical data, section Electrical data)			
3.2	Charger: housing with plug undamaged (e.g. no cracks in the housing, plug is not bent or loose)			
3.3	Charger: rating plate/imprints present, attached and legible			
3.4	Power supply line: routed correctly, undamaged, not crushed/shorn, no risk of catching			
3.5	No visible damage of the electrical system (e.g. no cracks on cases, fork heads and lift pipes).			
3.6	All sockets on the control unit are closed with plugs or dummy plugs with sealing ring. The sealing rings are not torn or porous			
3.7	The lift drive / spreader drive is securely attached. The fasteners for the lower fork head on the case and the fasteners for the top fork head on the lift pipe are secured with the bolt and locking plate, or the tube clip is installed correctly (see chapter on Assembly).			
3.8	Note service life of the batteries: Batteries must be replaced after 4 years at the latest			
3.9	Manual control unit: no damage (e.g. fractures)			
3.10	Manual control unit: no soiling or other abnormalities			
3.11	Manual control unit: functional, no warning signals			
3.12	Manual control unit: front film completely adhered over the entire surface			
3.13	Charger directly connected - no additional power sockets such as multiple sockets used for connection			
3.14	Charging process indicator: - indicator lights on the charger are working <ul style="list-style-type: none"> • Yellow LED lights up = battery pack is charging • Green LED lights up = battery pack fully charged 			

Maintenance schedule continues on next page.

4	Function test Important: The product must have passed the visual inspection! - The battery pack must be mounted (see chapter on Operation, section Battery pack) - The emergency stop button must be unlocked (see chapter on Operation, section Emergency stop button)	OK	NOK	n/a
4.1	Castors: Parking brakes can be locked and released without faults			
4.2	Castors: easy running, can be swivelled, no unusual noises			
4.3	Battery pack: can be removed and reinserted without difficulty (see chapter on Operation, section Battery pack)			
4.4	Chassis: can be spread with the foot pedal or the manual control unit and the spreader drive to the intended width (dimension "p") and moved back to parallel position (see chapter on Operation, section Spreading and chapter on Technical data)			
4.5	Emergency stop button can be pressed and it engages; interrupts any electrically operated movement (see chapter on Operation, section Emergency stop button)			
4.6	Emergency stop button unlocks by turning it clockwise (see chapter on operation, section Emergency stop button).			
4.7	Electrical emergency lowering functions without faults and can be stopped at any time (see chapter on Operation, section Emergency lowering)			
4.8	Mechanical emergency lowering functions without faults and can be stopped at any time (see chapter on Operation, section Emergency lowering)			
4.9	Manual control unit: All buttons of the manual control unit are functional during performance of the adjustment functions.			
4.10	Drives can be moved over the entire adjustment range (limit switches in both directions, no unusual noises).			
4.11	Charger: Charge status indicator lights up (see chapter on Operation, section Battery pack)			
4.12	Connection elements: Pin with locking plate can be operated as intended			
4.13	Connection elements: Pin with linchpin can be operated as intended			
4.14	Connection elements: Tube clip can be operated, opened and closed as intended			
4.15	Connection elements: Clamping lever can be operated as intended			
4.16	Connection elements: Star handle can be operated as intended			
4.17	Adjustable elements: Stand mast can be adjusted as intended and secured with the connecting elements			
4.18	Adjustable elements: Lifting arm can be adjusted as intended and secured with the connecting elements			
Overall assessment of the aks patient hoist				

Maintenance schedule continues on next page.



Perform the operating load test with weight plates, for example. Attach the weight plates to the lifting arm with a suitable holder. The different purposes must be considered (conventional patient hoists vs. movable standing-up hoists).

The location of the inspection must be such that the inspection does not cause any impairment/damage to the persons involved in the inspection (physical injury) and/or of the inspection site (property damage). Implement suitable measures in advance (e.g. barriers, warning sign, training courses). Note that failure of the patient hoist can suddenly release forces that can result in severe injuries / serious damage.

Operating load test	OK	NOK	n/a
Important: The product must have passed the visual inspection! In case of obvious damage, the product must no longer be used. Load the patient hoist with the permitted maximum load (see chapter on Technical data).			
Lifting arm can be moved electrically with the maximum load over the entire lifting range (dimension "m") and switches off in both end positions (dimension "l" and dimension "k") (see chapter on Technical data); motor self-locking is present			
Perform a visual inspection and check the product for damage. After the inspection, no part may display signs of damage or wear			
Leave the patient hoist in the test equipment with the permitted maximum load and perform a second visual inspection after two (2) minutes ² to check the product for damage. After the inspection, no part may display signs of damage or wear			

Item	Inspection of the aks spreader bar – check points*	OK	NOK	n/a
1.1	Rating plate present, attached and legible			
1.2	No damage (e.g. corrosion, deformation, sheared weld seams)			
1.3	No wear (e.g. worn/abraded areas)			
1.4	Spreader bar padding present and undamaged (e.g. tears, holes, blistering, worn areas) Exception: aks horizontal transport spreader bar with 8-point attachment (no padding)			
1.5	Caps and dummy plugs present and undamaged			
1.6	All hooks present, undamaged and not bent			
1.7	aks horizontal transport spreader bar with 8-point attachment: all suspension brackets present, attached, undamaged and not bent			
1.8	aks horizontal transport spreader bar with 8-point attachment: all hooks present, undamaged and not bent			
1.9	aks horizontal transport spreader bar with 8-point attachment: retaining bolt present, undamaged and attached			
Overall assessment of the aks spreader bar				

Maintenance schedule continues on next page.

2 Reference to EN ISO 10535: It takes approx. two (2) minutes to perform one (1) lifting cycle; this can vary according to the hoist/drive manufacturer.

Perform maintenance of the aks hoist sling at least every six months and before each reuse.

EN ISO 10535 specifies the following among other things in Annex B:



*“Periodic inspection of a flexible bodily support system should be performed at the intervals specified by the manufacturer, but **at least every 6 months**. More frequent inspections may be necessary if a flexible bodily support system is used or cleaned more frequently than normal.”*
“Each inspection should include an operating load test with one (1) lifting cycle at the maximum load.”

Item	Inspection of the aks hoist sling – check points*	OK	NOK	n/a
1.1	Rating plate present, attached and legible (see chapter on Product labelling)			
1.2	Patches present, attached and legible (see chapter on Product labelling)			
1.3	Instructions for use available, legible and accessible to user			
1.4	No damage to textiles (e.g. torn, cut, punctured, blistered, scorch marks)			
1.5	No damage to straps or sling loops (e.g. tears, holes, fraying)			
1.6	Number of sling loops and suspension positions correct (see chapter on Preparation, section Sling loops – instructions for use for hoist sling in question)			
1.7	No damage to seams (e.g. undone or torn seams), seams are complete (i.e. no damage on the top or bottom, fabric layers are connected, seams/threads are strong)			
1.8	No wear (e.g. worn/abraded areas)			
1.9	No fading			
1.10	No soiling/damage from chemicals			
1.11	For hoist slings with reinforcement: Reinforcing elements present and undamaged (see chapter on Product overview – instructions for use of the hoist sling in question)			
1.12	For hoist slings with Velcro fastening: Velcro fastening sewn on firmly and fully functional (see chapter on Product overview – instructions for use of the hoist sling in question)			
1.13	For hoist slings with push-fit fastening: Push-fit fastening present, undamaged and functional (plug is held securely in the housing) (see chapter on Product overview – instructions for use of the hoist sling in question)			
Overall assessment of the aks hoist sling				

Maintenance schedule continues on next page.



If in doubt, e.g. no clear result delivered by visual inspection, an operating load test with the permitted maximum load (see chapter on Technical Data) should be performed.



During inspection of a hoist sling, the load/inspection device should imitate the body to be lifted/uprighted. The different purposes must be considered (conventional patient hoists vs. movable standing-up hoists).

The location of the inspection must be such that the inspection does not cause any impairment/damage to the persons involved in the inspection (physical injury) and/or of the inspection site (property damage). Implement suitable measures in advance (e.g. barriers, warning sign, training courses). Note that failure of the hoist sling can suddenly release forces that can result in severe injuries / serious damage.

Operating load test Important: The product must have passed the visual inspection! In case of obvious damage, the product must no longer be used. Perform the load test for all sling loops and attachment positions!	OK	NOK	n/a
Subject the hoist sling to the permitted maximum load. Perform a visual inspection and check the product for damage. After the inspection, no part may display signs of damage or wear			
Leave the hoist sling in the test equipment with the permitted maximum load and perform a second visual inspection after two (2) minutes ³ to check the product for damage. After the inspection, no part may display signs of damage or wear			



Do not use a damaged or severely worn product. Failure to observe this requirement may cause the patient to fall, and thus result in severe or even fatal injury to the patient.

Item	Inspection of the wall charging station accessory – check points*	OK	NOK	n/a
1.1	Rating plate present, attached and legible			
1.2	No damage to plugs, power supply line, case, rating plate and display			
1.3	Green LED (“ON”) indicates that the wall charging station is operational (see chapter on Operation, section Battery pack)			
1.4	Yellow LED (“CHARGE”) indicates the charging process of the battery pack (see chapter on Operation, section Battery pack)			
1.5	Power supply line: routed correctly, undamaged, not crushed/shorn, no risk of catching			
1.6	Power supply line: the device plug engages in the connection socket on the wall charging station and cannot be pulled out again (see chapter on Assembly, section Assembly of the wall charging station accessory)			
1.7	Power supply line: the connector plug sits correctly in the mains socket (see chapter on Assembly, section Accessories: wall charging station – assembly)			
1.8	Battery pack: can be removed and reinserted without difficulty (see chapter on Operation, section Battery pack)			
Overall assessment of the wall charging station accessory				/

Overall assessment of aks patient hoist, aks spreader bar, aks hoist sling and wall charging station (optional)			
aks patient hoist and accessories are in order:		<input type="checkbox"/> YES	<input type="checkbox"/> NO
Remark:			
Test date	Company	Inspector	Signature

Data: aks patient hoist, aks spreader bar, aks hoist sling and wall charging station (optional)				
Product	Model	SN	Date of manufacture	Next maintenance/ inspection
Patient hoist				
Accessories				
Hoist sling				
Spreader bar				
Wall charging station				

3 Reference to EN ISO 10535: It takes approx. two (2) minutes to perform one (1) lifting cycle; this can vary according to the hoist/drive manufacturer.

19.3 Maintenance schedule: Inspection by the user

In addition to the periodic checking by suitable qualified personnel, the user must check that the product (incl. accessories) is in a safe state before each use. Do not use the product/accessories if you are concerned about the safety of doing so. Contact your authorised dealer immediately.

The following maintenance schedule provides help for this inspection:

Inspection of the aks patient hoist – check points
Patient hoist shows no obvious damage or wear
Attachment points show no damage or wear
No unusual noises
Manual control unit: no damage (e.g. fractures), front foil glued completely and over the entire surface , no soiling or other abnormalities
Manual control unit: Function available, no warning signal
Emergency stop button can be pressed and it engages; interrupts any electrically operated movement
Inspection of the aks spreader bar – check points
No damage (e.g. corrosion, deformation, sheared weld seams)
No wear (e.g. worn/abraded areas)
Spreader bar padding present and undamaged (e.g. tears, holes, blistering, worn areas) Exception: aks horizontal transport spreader bar with 8-point attachment (no padding)
Caps and dummy plugs present and undamaged
All hooks present, undamaged and not bent
aks horizontal transport spreader bar with 8-point attachment: all suspension brackets present, attached, undamaged and not bent
aks horizontal transport spreader bar with 8-point attachment: all hooks present, undamaged and not bent
aks horizontal transport spreader bar with 8-point attachment: retaining bolt present, undamaged and attached
Inspection of the aks hoist sling – check points
No damage to textiles (e.g. torn, cut, punctured, blistered, scorch marks)
No damage to straps or sling loops (e.g. tears, holes, fraying)
Number of sling loops and suspension positions correct (see chapter on Preparation, section Sling loops - instructions for use for hoist sling in question)
No damage to seams (e.g. undone or torn seams), seams are complete (i.e. no damage on the top or bottom, fabric layers are connected, seams/threads are strong)
No wear (e.g. worn/abraded areas)
No fading
For hoist slings with reinforcement: Reinforcing elements present and undamaged (see chapter on Product overview - instructions for use of the hoist sling in question)
For hoist slings with Velcro fastening: Velcro fastening functional and seams intact (see chapter on Product overview - instructions for use of the hoist sling in question)
For hoist slings with push-fit fastening: Push-fit fastening present, undamaged and functional (plug is held securely in the housing) (see chapter on Product overview - instructions for use of the hoist sling in question)

Maintenance schedule continues on next page.



Do not use a damaged or heavily worn product/accessories. Failure to observe this requirement may cause the patient to fall, and thus result in severe or even fatal injury to the patient.

Inspection of the wall charging station accessory – check points
No damage to plugs, power supply line, case, rating plate and display
Green LED („ON“) indicates that the charger is connected properly (see chapter on Operation, section Battery pack)
Yellow LED („CHARGE“) indicates the charging process of the charger (see chapter on Operation, section Battery pack)
Power supply line: routed correctly, undamaged, not crushed/shorn, no risk of catching
Power supply line: the device plug engages in the connection socket of the wall charging station and can no longer be pulled out (see chapter on Assembly, section Accessories: wall charging station – assembly)
Power supply line: the connector plug sits firmly in the mains socket (see chapter on Assembly, section Accessories: wall charging station – assembly)
Battery pack: can be removed and reinserted without difficulty (see chapter on Operation, section Battery pack)



If any checks indicate defects/damage, immediately disconnect the product from the mains supply and do not use it again. Press the emergency stop button and remove the battery pack (see chapter on Operation, section **Emergency stop button** and section **Battery pack**). Mark the product clearly as “out of order” and inform your authorised dealer immediately.

20 Product labelling

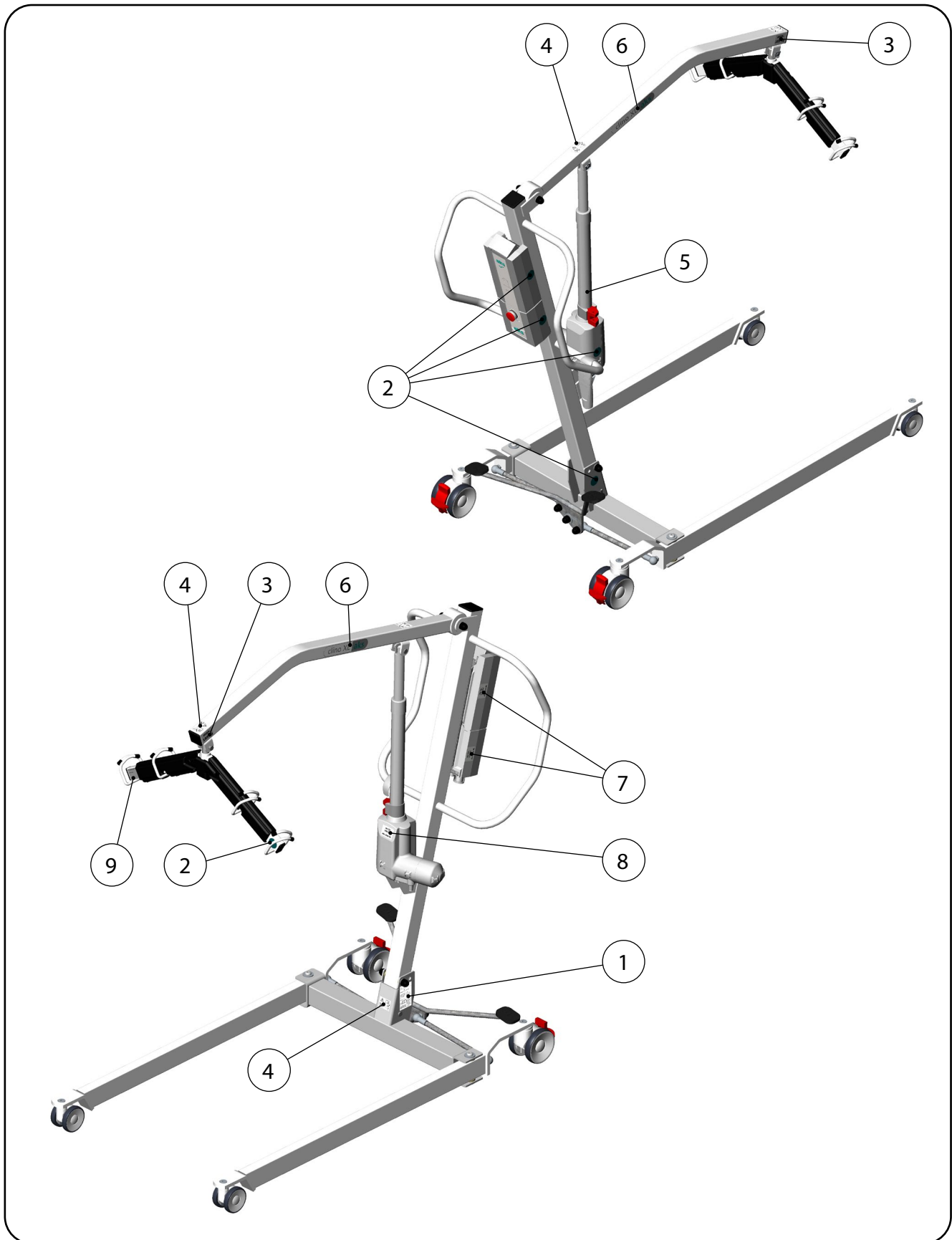











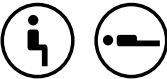









Fig. 20.01 - clino[®] XL
Colour: Light grey, RAL 7035

Product labelling			
Item		Item	
1	<p>aks Aktuelle Krankenpflege Systeme GmbH Antwerpener Straße 6 D-53842 Troisdorf www.aks.de</p>		<p>Sticker Date of manufacture</p>
	<p>Rating plate (technical) aks patient hoist (SN: 10-digit)</p>	<p>Rating plate (organisational) aks patient hoist (SN: 10-digit)</p>	<p>3</p> <p>Sticker Maximum load</p>
4	<p>Sticker Follow instructions for use</p>	<p>Safety instruction for locking plate</p>	<p>5</p> <p>Safety instruction for Lift drive do not exert any lateral forces!</p>
	<p>6</p> <p>Product sticker</p>	<p>7</p> <p>Sticker (control unit, battery pack) only for clino[®] XL</p>	
8	<p>Sticker (lift drive, spreader drive) only for clino[®] XL</p>	<p>9</p> <p>Rating plate Spreader bar</p>	

z4200210_GA_Lifter_clino-XL_210531_Rev01_GB

Explanation of the symbols	
	CE-Marking – this product satisfies the applicable requirements of the Regulation (EU) 2017/745 on Medical Devices (MDR) and other legal requirements of the European Union regarding affixing the relevant marking.
	Dimensions of the product
	Medical device as per Regulation (EU) 2017/745 on medical devices
Class I	Class I according to Regulation (EU) 2017/745 on medical devices (MDR), Annex VIII
	<u>U</u> nique <u>D</u> evice <u>I</u> dentifier (UDI) - means a series of numeric or alphanumeric characters that allows unambiguous identification of specific devices on the market
	Follow instructions for use (ISO 7010-M002)
	permitted maximum load
	The batteries contained in the product are subject to the Batteries Act (BattG) and must not be disposed of with household waste.
 Pb	The batteries contained in the product are subject to the Batteries Act (BattG) and must not be disposed of with household waste. The battery contains lead (Pb).
	WEEE marking (the device must not be disposed of with domestic waste)
	Use: sitting
	Use: lying
	Use: sitting and lying
	Only use in combination with aks standard spreader bar
	Only use in combination with: aks tandem spreader bar or goliath [®] comfort spreader bar
	Only use in combination with: aks horizontal transport spreader bar with 8-point attachment

Explanation of the symbols		EN ISO 15223-1
	Observe instructions for use	
	Attention	
	Manufacturer	
	Date of manufacture	
	Article number	
	Serial number	
	Air pressure, limit	
	Humidity, limit	
	Temperature, limit	
	Keep dry/store in a dry place	
	Protect against heat/sunlight	
	Fragile, handle with care	
Explanation of the symbols		IEC 60417
	For indoor use only	
	Protection class II against electric shock	
	Application part type B	
	Top	

Explanation of the care symbols		EN ISO 3758
	Coloured wash (normal washing cycle) Washing temperature 60 °C, normal process	
	Do not bleach Use bleach-free detergents	
	Dry with reduced thermal load Dry at low heat setting (maximum approx. 60 °C)	
	Do not iron	
	Do not dry clean	

Protection type of the enclosure acc. to EN 60529	
IPXX	First digit: Level of protection against contact and foreign objects Second digit: Level of protection against water
IPX4	4 - Protection against splash water on all sides
IPX5	5 - Protection against water jets (nozzle) from any angle
IPX6	6 - Protection against high-pressure water jets (nozzle) from any angle

21 Technical data

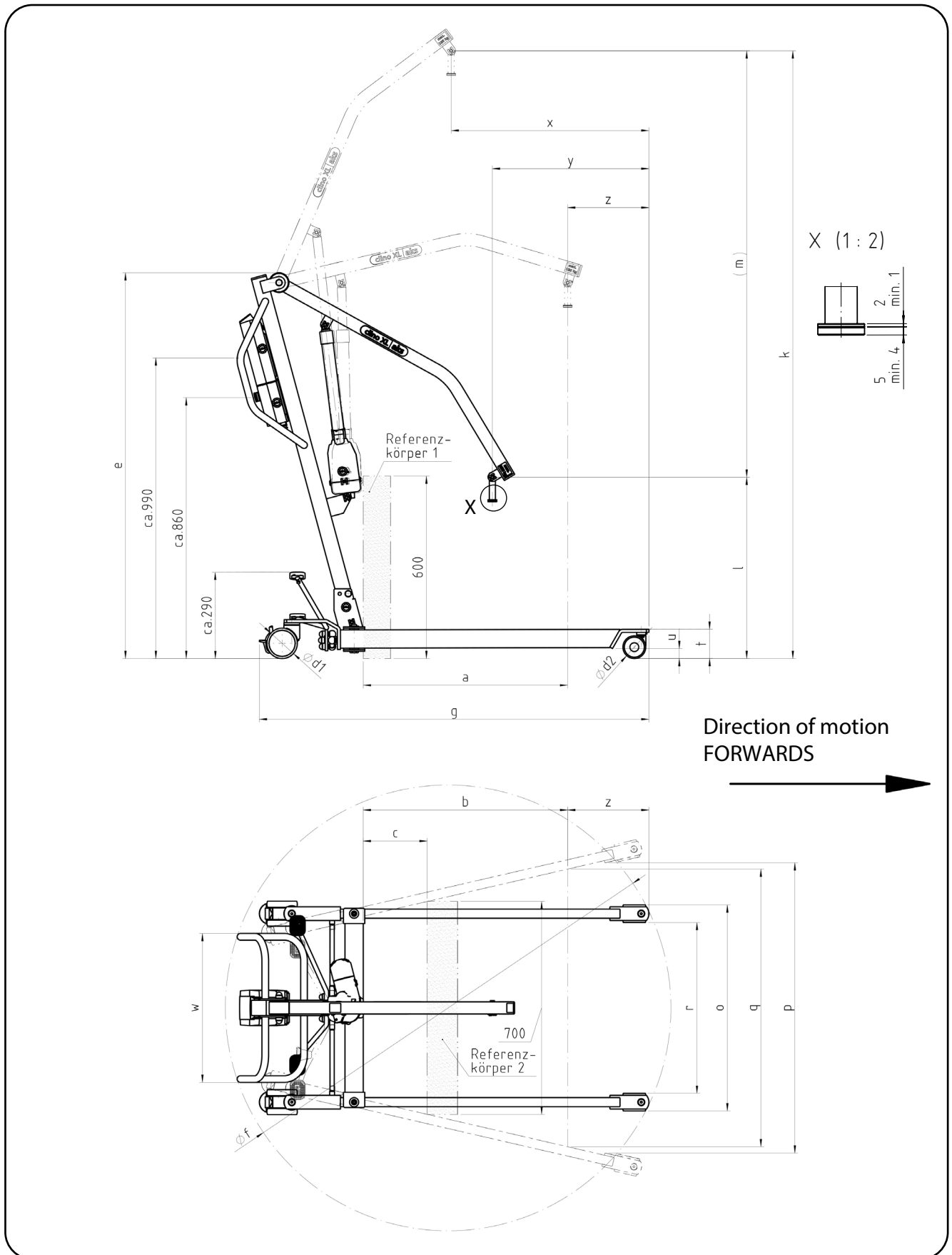

Fig. 21.01- Dimensional drawing, in this case clino[®] XL:
Dimensions (L x W x H): 1,280 x 680 x 1,270

General information on the products			
Classification	active class I medical device according to Regulation (EU) 2017/745, Appendix VIII		
Basic UDI DI	425181871883012HU		
Maximum load [kg]	185		
Operating force for the manual control unit [N]	< 5		
Climate conditions	Ambient temperature [°C]	Use	5 to 40
		Transport/storage	-10 to 50
	Humidity [%]	– Non-condensing – 20 to 80	
	Air pressure [hPa]	800 to 1060	
		Normally composed atmospheric air	
Dimensions			[mm]
a	Maximum range at 600 mm reference height		680
b	Maximum range from the chassis		680
c	Range of the chassis when the leg supports are spread to 700 mm		205
d1	Castor diameter, rear		100
d2	Castor diameter, front		75
e	Overall height		1,270
f	Turning diameter		1,470
g	Chassis length		1,280
h	Height of the shin support (top edge)		–
i	Height of the footboard		–
k	Max. attachment height		1,990
l	Min. attachment height		600
m	Lifting range		1,390
o	Min. outer width		680
p	Max. inner width		960
q	Inner width at maximum range of the attachment point		920
r	Min. inner width		550
t	Height of the chassis		100
u	Chassis clearance		30
w	Grab handle width		490
(x)	Minimum distance from the wall to the attachment point at its greatest height		650
(y)	Minimum distance from the wall to the attachment point at its lowest height		525
(z)	Minimum distance from the wall to the attachment point at maximum range		275
Weights			[kg]
Total weight (without spreader bar and hoist sling)	clino[®] XL		40
	clino[®] e XL		42

All specifications regarding dimensions and weights are approximate specifications.

Additional information on the products			
Materials used	- Steel (powder-coated or galvanised) - Commercially available plastics (POM, ABS, PP, PVC, PA6.6) - Rubber		
Sound pressure level	51 dB(A) at a distance of 1 m		
Electrical data		LINAK GmbH	
Charger	Input	100-240 V ~ (AC); 50-60 Hz; 260-140 mA; 25 VA	
	Output	24 V = (DC); 500 mA; 12 VA	
	Protection type	IP40 (without plug) Use only with the plug attached!	
Control unit	Input	24 V = (DC); max. 500 mA	
	Protection type	IPX4 (with battery pack attached)	
Battery pack	Operating voltage	24 V = (DC)	
	Capacity	2,9 Ah	
	Protection type	IPX5 (with battery pack attached)	
	Battery type	Lead gel battery (Pb)	
	Charge time	24 h	Before initial use
		4 - 12 h	Depending on state of charge
		> 3 days	Battery pack defective, replace
Self-discharge	approx. 3 months		
Lift drive	Input	24 V = (DC); max. 10,5 A	
	Max. current consumption	10 A (at 10,000 N)	
	Protection type	IPX4	
	Speed	7,0 mm/s at 10.000 N	
Spreader drive	Input	24 V = (DC); max. 2,4 A	
	Max. current consumption	2,4 A (at 2.500 N)	
	Protection type	IPX4	
	Speed	6,8 mm/s at 2.500 N	
Manual control unit	Protection type	IPX4	
Switch-on cycle	On-time	max. 10 % oder 2 minutes continuous operation	
	Switch-off duration	min. break 18 minutes	
	Switching cycles	max. 5 per minute	
Electrical data for accessories		LINAK GmbH	
Wall charging station	Input	100-240 V ~ (AC); 50-60 Hz	
	Output	29,5 V = (DC); max. 19 VA	
	Protection type	IPX5	
	Protection class	II	
	Application part	type B	
	Charging current	max. 400 mA	
	Charge time	see battery pack	



The product fulfils the requirements of the RoHS, REACH and WEEE regulations/guidelines, among other requirements.

All parts and data are subject to constant further development and can thus be different from the information shown in this document.

Notes:

Notes:

Notes:

Enter the data for your product here:

- Type:**
- foldy® micro
 - foldy® mini
 - foldy®
 - foldy® XL
 - clino® II
 - clino® XL
 - goliath®
 - foldo®
 - foldy® e mini
 - foldy® e
 - foldy® e XL
 - clino® e XL

UDI (01)042518187__ _ _ _ _

SN _____
Chassis

 year _____ month _____

First time use: year _____ month _____

Authorised dealer: Name _____
Street _____
Postcode/town _____
Telephone number _____

Battery replaced on:

Date: _____
Date: _____
Date: _____
Date: _____

Notes:



aks Aktuelle Krankenpflege Systeme GmbH
Antwerpener Straße 6
D-53842 Troisdorf

📞 +49(0)2241/9474-0
📠 +49(0)2241/9474-88
✉️ aks@aks.de
🌐 www.aks.de

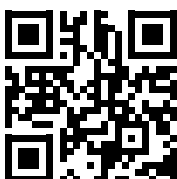

Reprints whether in whole or in part are only allowed with prior permission by the publisher.
All rights reserved, particularly the right to make technical amendments. Printing errors excepted.